

# INSTRUCTIONS FOR USE

for REAL 8200 PLUS Mammography  
Medical Clinic Chairs

Instructions for use and care



EN

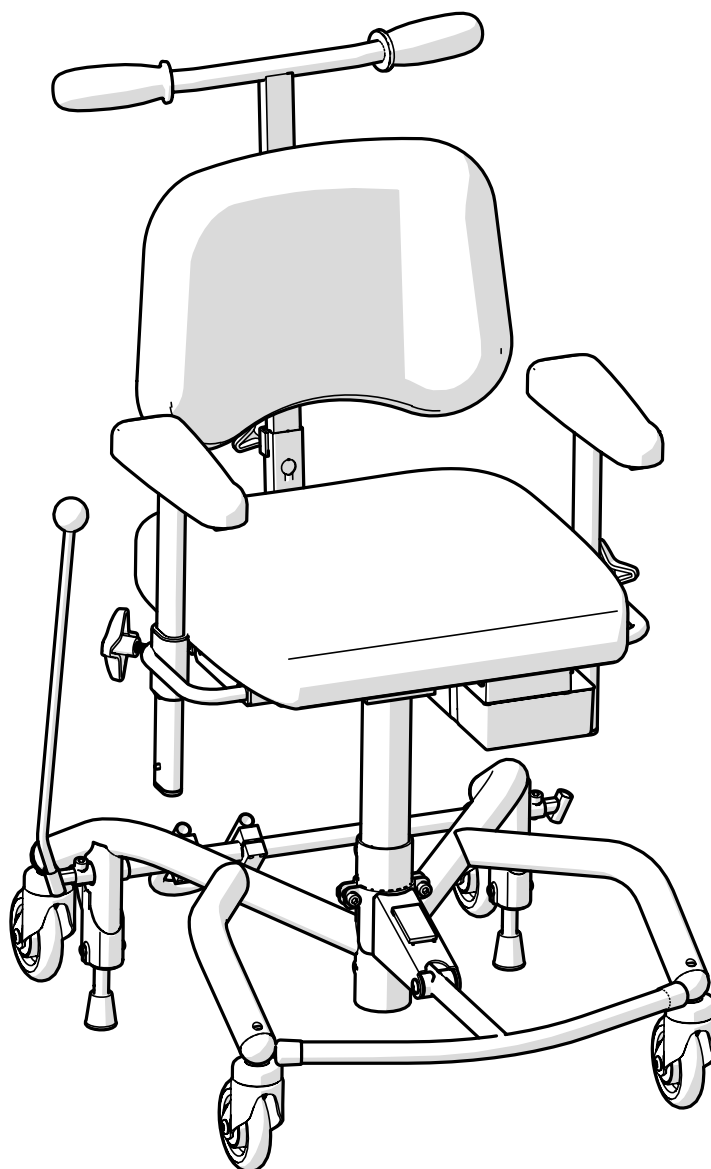

Translation of manual  
Item number: 21-08996-EN  
Revision: 02  
Valid from: 2021-05-26  
Amended: 2022-06-01



[Space for device label with  
serial number]

# Table of contents

## User information

1. Introduction	4
1.1. Contact details	5
1.2. Warranty	5
2. Getting started	6
2.1. Before use	6
2.2. How to use the device's functions	8
2.3. Charging	9
3. Caring for the device	10
3.1. Upholstery	10
3.2. Castors and brake feet	10
3.3. Other parts	10
3.4. Transport and storage	11

## Device information

4. intended use	12
4.1. Product environment	12
5. Configurations and settings	13
5.1. Required level of competence for setting and adjusting	13
5.2. Basic model	14
5.3. Electrical functions	15
5.4. Seat	16
5.5. Back support	16
5.6. Backrest mechanism	17
5.7. Arm rest cushion	17
5.8. Armrest mechanism	18

5.9. Neck support	19
5.10. Base	20
5.11. Manual brake	20
5.12. Individual customisation	22

6. Important safety information	23
6.1. Standards met and classification	23
6.2. Warnings	24
6.3. Expected service life	25
6.4. Reporting of adverse events and incidents	26

## Service manual

7. Technical information	27
7.1. Symbols	29
8. Servicing & reconditioning	31
8.1. Troubleshooting guide	32
8.2. Battery replacement	34
8.3. Reconditioning and periodic maintenance	35
9. Instructions for destruction	41
9.1. Recycling	41

# 1. Introduction

Thank you for choosing Mercado Medic as the supplier of this device. By choosing a REAL chair, you get to learn about a 50-year history of developing medical devices with high function, safety, quality and flexibility. We manufacture all our different medical chairs under our own management in Sweden.

Mercado Medic is certified to ISO 13485, ISO 9001 and ISO 14001, and complies with applicable labour and environmental legislation.

We reserve the right to make changes to this manual and its contents.

Sufficient competence in the safe use of this device is achieved by carefully reading through these instructions for use before using the device for the first time.

**PDF versions of our instructions for use with zoom options are always available in their most current version on our website [www.mercado.se](http://www.mercado.se).**



### 1.1. Contact details

#### Manufacturer

Street address: Mercado Medic AB,  
Tryffelslingan 14, SE-181 57 Lidingö, Sweden

Postal address: Mercado Medic AB,  
Box 1074, SE-181 22 Lidingö, Sweden  
Telephone: +46 (0)8 555 143 00  
Email: [info@mercado.se](mailto:info@mercado.se)  
Website: [www.mercado.se](http://www.mercado.se)

#### Servicing and technical support

Telephone: +46 (0)8 555 143 08  
Email: [service@mercado.se](mailto:service@mercado.se)

To report warranty claims, adverse events and incidents or other feedback please use the form at [www.mercado.se/en/support/](http://www.mercado.se/en/support/).

#### Distributor

Space for additional distributor contact details:

-----  
-----  
-----  
-----

### 1.2. Warranty

All components of Mercado Medic's devices are covered by warranty, under the time periods and general terms and conditions set out below, unless other specific periods and conditions are agreed in writing between Mercado Medic and the contracting customer in connection with major procurements.

As the operator, you must contact your distributor if you experience problems with the device. Distributors in turn should contact Mercado Medic using the contact details available under Section 1.1. Contact details.

#### Warranty periods

- Metal structures: 3 years.
- Electric lifting mechanism: 2 years.
- Other components (e.g. wheels, batteries, padded parts): 1 year.

#### General terms and conditions

The warranty does not cover:

- Damage or condition considered to be normal wear and tear.
- Damage caused by negligence or misuse.
- Spare parts, components or accessories not sold by Mercado Medic.
- Adjustments to the device made by unauthorised service technicians.
- Components previously fitted to devices other than the item in question.
- Bleaching or natural variations in the colours of faux leather.

## 2. Getting started

As the operator of the device, this section is primarily aimed at you. It describes how to prepare the device for use, how to use its functions, and how to charge it. For care instructions, see 3. Caring for the device.

If you have any questions about the device or if something unexpected has happened, please contact your distributor first. You can find up-to-date contact details in Section 1.1. Contact details. You are also welcome to contact us at Mercado Medic.

### 2.1. Before use

All devices come with a seat, back rest, armrests, a brake and electric height adjustment. When delivered from Mercado Medic, the back rest and brake lever may not yet be fitted. These should always be fitted before the device is first used.

#### Backrest mechanism

For models with back rest, insert the back rest pole into the back rest mechanism (B) and adjust to the desired height, see Figure 2.1. Tighten all levers (A).

#### Brake lever

We recommend that the brake lever not be mounted if you intend to use the foot brake. If you intend to use the handbrake function, mount the brake lever as follows: Insert the brake lever into the brake lever bracket (A), see Figure 2.1. The brake lever can be placed on the right or left side.

#### Armrests

Loosen the armrest controls (C) and set the desired height and width levels, see Figure 2.1. Tighten all controls (C).

#### Neck support

If the device is supplied with a neck support, insert the neck support mechanism into the backrest bracket (D) and set the desired height level, see Figure 2.1. Tighten all controls (D).

#### Battery

Before initial use, activate and charge the battery. This is done by connecting the battery charger to the device's charging socket and to a wall outlet (E), see Figure 2.1. The charging socket can be placed in different places on the device. The device is usually delivered with the charging socket mounted at the rear edge under the seat.

Wait until the battery is fully charged before using the device. This normally takes 2 to 5 hours. When the battery is fully charged, the LED on the charger lights up green. For other charging instructions, see 2.3. Charging.

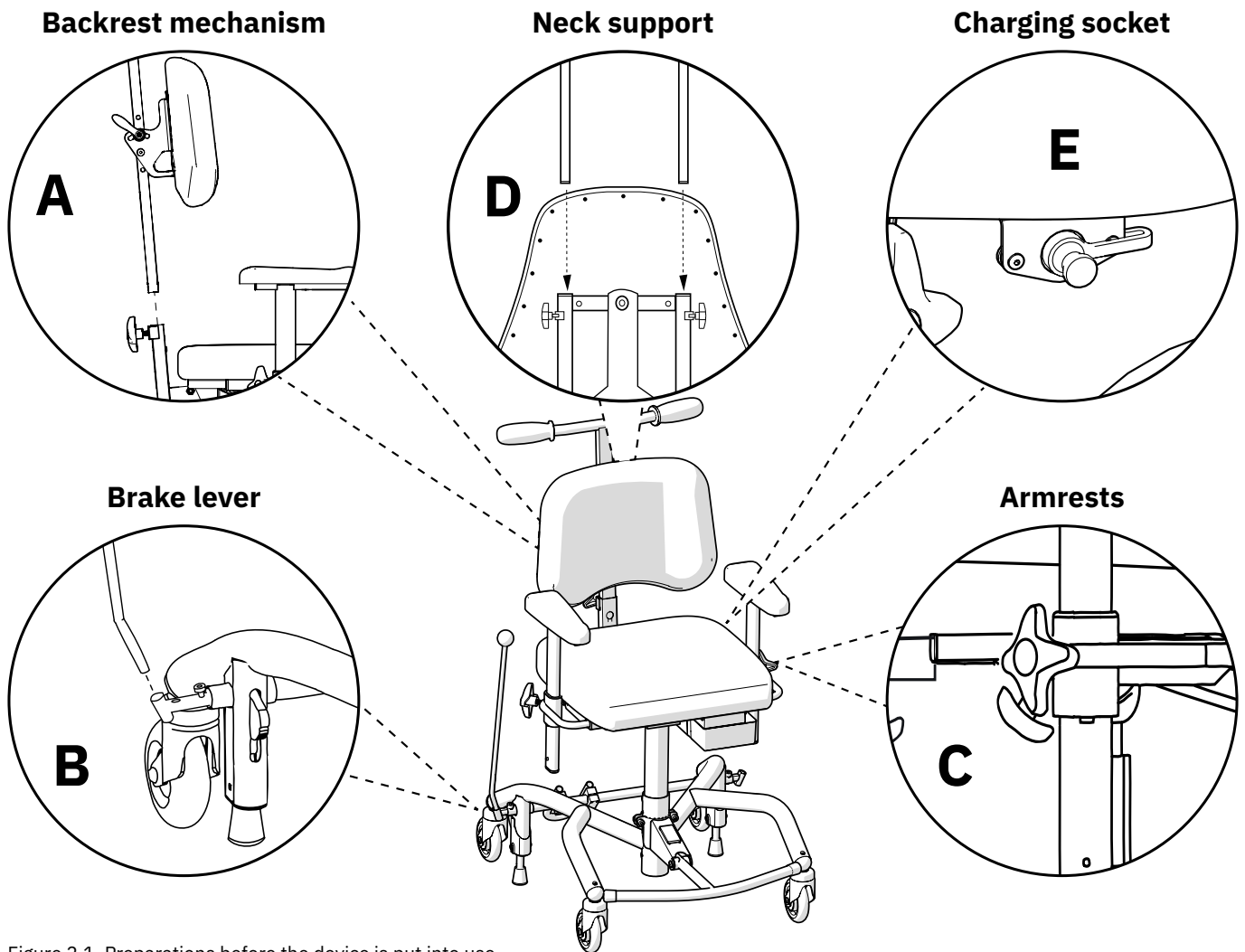

Figure 2.1. Preparations before the device is put into use.

**Consider the following before and during use of the device**

- Tighten all setting controls before putting the device into service.
- The device must not be used without fitting the backrest.
- The device must not be used without fitting the armrests.
- The brake on the device must always be applied when the patient gets in and out of the chair.
- The braking capacity of the device may be impaired on heavily sloping floors.
- The braking capacity of the device may be impaired on uneven floors.
- The device must be operated with care.
- The foot ring is designed to rest your feet on, not to stand on.
- Charge the device according to these instructions for use, see 2.3 Charging.
- The electrical functions cannot be used when the device is charging.
- If the device is equipped with leg supports, the patient’s feet must always be in contact with the foot plate when the electrical functions are used.
- Never set the seat to a height that makes it unsafe for the patient to get out of the device.

- The device must not be moved when the seat is in the raised position.
- Remote control emergency stop:  
If, for whatever reason, the system does not interrupt a movement after the corresponding control button has been released, the movement can be interrupted by pressing any of the other buttons on the hand-held controller.
- Button lock on remote control: To enable or disable the button lock for a function, press and hold both of the directional buttons of the relevant function for at least three seconds. The button lock locks only the current function. To lock multiple functions, each function must be locked separately.



Warning! As a user, you should contact your distributor if device performance deteriorates or changes. A device showing a loss of or change in performance must immediately be taken out of use in order to avoid an accident. The device must not be used again until an authorised technician has examined the device.



Warning! You are not permitted to modify the device yourself. Please contact your distributor if you would prefer individual customisation. If the device is modified, the CE marking no longer applies and Mercado Medic may no longer have full device liability. Modifications may affect the safety of the device and lead to accidents.



Warning! The device may be equipped with long cables or wires that cannot be secured in order for the device to function properly. Cables and wires can pose strangulation risks to small children, for example. Do not leave the device unattended with small children nearby.



Warning! The device is equipped with small parts such as screws that can come loose. Small parts that have come loose can pose a potential choking hazard for children.



Warning! Metal surfaces may become very hot if they are exposed to direct sunlight. Skin contact with hot surfaces can lead to burns. Avoid exposing metal surfaces to direct sunlight.



Warning! Always make sure that the device's brake is applied when the patient sits down and gets up. If the device's brake is not applied, there is a risk that the device will roll away when the patient stands up or sits down, which could cause fall injuries.

## 2.2. How to use the device's functions

The device has remote-controlled electric height adjustment, see Figure 2.2. The device is also equipped with manual foot brake and hand brake. The manual foot brake is activated and deactivated via a pedal and the manual hand brake is activated by pushing the brake lever forwards and deactivated by pulling the brake lever backwards, see Figure 2.2. We recommend not mounting the brake lever if you intend to use the foot brake. Depending on the model, the device may be equipped with an electric seat tilt and an electric back rest mechanism. These are remote-controlled, see Figure 2.2. See 5. Configurations and settings for detailed information about all the features and controls of the device.



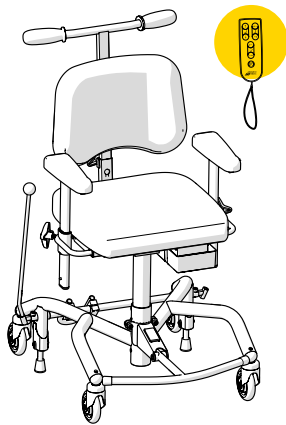

Figure 2.2. Controls on the electric model.

### 2.3. Charging

The battery should be charged once every 24 hours. Fully charging the battery on a daily basis will take 2 to 5 hours. It is important that the battery is never completely discharged, as this helps to prolong the life of the battery. Daily battery charging is especially important for configurations with an electric brake and seat tilt. The device emits a low battery level warning sound, for both low and critical. Low battery is indicated by a short signal. Critical battery level is indicated by a short signal that ends with a loud beep. The product can also indicate low or critical battery levels using a signal when the product's battery is activated after the system has been in sleep mode. This is because when starting up, the product has not yet determined its charge level. This signal stops after two minutes.

The device must be charged in a safe manner. The electrical functions cannot be used when the device is charging. For this reason, choose an easily accessible wall socket to plug the charger into. The charger cable to the wall socket is 1 metre long and must not be extended. In case of emergency, disconnect the device from the mains by unplugging the charger from the wall socket.

#### How to charge the device

1. Inset the plug into the charging socket (see Figure 2.3). The charging socket is usually located at the rear edge under the seat.
2. Connect the charger plug into the wall socket. The LED on the charger will indicate that charging is underway.
3. The battery is fully charged when the LED on the charger changes colour from red to green. This is shown by the three green battery LEDs on the remote control's battery indicator flashing in sync.

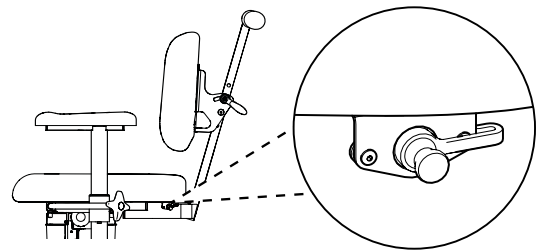

Figure 2.3. Plug connection to the charging socket under the seat.

If the electrical functions have not been used for 7 days, the battery switches off automatically. To reconnect the battery, connect the battery charger to the charging socket and the wall outlet and wait at least 5 seconds before unplugging the charger. It is recommended to charge the battery fully after the battery has been disconnected.

If no electrical functions are working, try charging the battery. Contact your distributor if electrical functions still do not work, see 1.1. Contact details.

## 3. Caring for the device

Clean the device in accordance with the instructions in this section in order to maintain functions and service life. If needs arise that cannot be resolved with the resources available, please contact your distributor for reconditioning.

PLEASE NOTE! Do not wash the device with water or other liquids and chemicals.

### 3.1. Upholstery

To prevent contamination, device upholstery must be cleaned after each period of use.

#### Synthetic leather padded parts

Use soap and water or surface disinfectant to clean synthetic leather padded parts. Start by removing any loose debris. Then use a cloth to clean the upholstery with soap and water or surface disinfectant. If the upholstery is cleaned using soap and water, finish by wiping with a clean, damp cloth.

### 3.2. Castors and brake feet

Regular cleaning of castors and brake feet is required to maintain the operation of the device. Wipe castors and brake feet with a damp cloth. Remove any hair from the castors using a thin crochet needle or similar implement.

### 3.3. Other parts

Do not clean the device’s lifting mechanism and other actuators, see Figure 3.1 (can be located in the electric seat tilt, back rest mechanism and leg supports). This is because there is a risk that the grease required for these mechanisms to function as intended might be removed during cleaning.

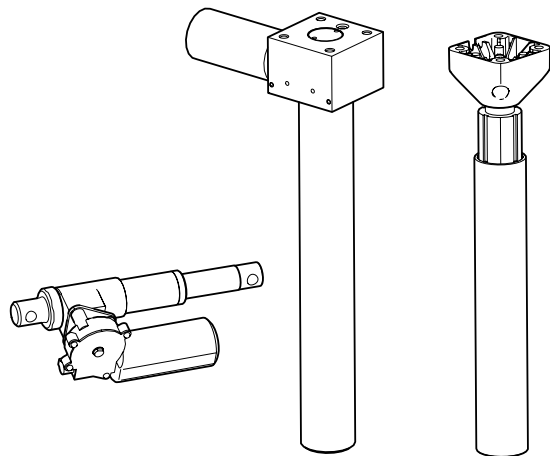

Figure 3.1. device’s lifting mechanism and other actuators.

If necessary, a dry cloth can be used to remove dust from any electronic parts of the device. Clean the other non-electronic parts of the device once a week or when necessary. Use a clean, damp cloth with mild detergent (pH 7-12), surface disinfectant or use a steam cleaner (max. 8 bar).

### 3.4. Transport and storage

When transporting and storing the device, keep the following in mind:

- The device moves by rolling on a flat surface.
- The device should be lifted by two people. Suitable grip points are at the front, rear, right and left sides of the seat, see Figure 3.2.

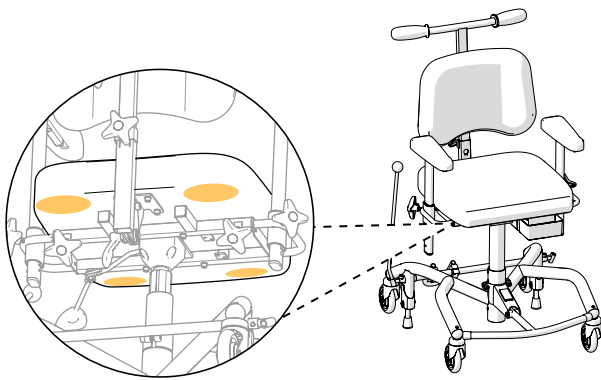
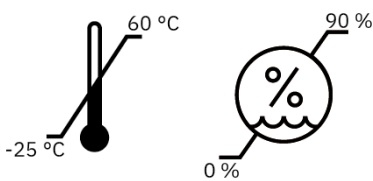

Figure 3.2. Suitable grips when lifting.

- The device must be transported in the intended cardboard box on a pallet. If the device is transported by car, it must be strapped in place using straps over both the base and the seat, and it should be set to the lowest possible seat height. To reduce the size of the device during transport, the backrest can be removed and the armrests lowered. Be sure to select the settings so that they can be easily reset. Tape or similar easily removable marking is recommended.
- The device must not be used as a seat when transported in a car or aircraft, for example.
- In the case of air transport, the device must be stored in the hold. Original Mercado Medic batteries are approved for air transport. For information on battery type, see 7. Technical information.

- The device is intended to be transported and stored at between -25°C to +60°C and up to 90% non-condensing relative humidity.



## 4. intended use

The REAL 8000 product range consists of modular patient seats designed to be used in combination with primary clinical examination equipment, such as X-ray machines. The device is intended to be used in conjunction with other medical devices in environments and situations that may require customised seat positions for different patients in order to be able carry out the examination efficiently and with satisfactory results. Applicable situations include, but are not limited to, mammography and other radiological examinations, as well as various kinds of ophthalmological examinations. REAL 8000 is designed to be used wherever a good seat position is required, such as in the following situations:

- the patient has to be able to cope with a complete examination.
- the patient needs support to remain still enough in order for the examination method to give satisfactory results:
- for example, the patient needs support to remain still enough during a biopsy.
- being able to carry out more efficient examinations in situations where there is a need to reduce the time the patient has to endure an emotional strain (such as during a mammogram).

The REAL 8000 product range is designed to be operated by a professional who ensures an appropriate adjustment in relation to both the patient and the primary examination equipment.

### Contraindications

There are no known contraindications for using the REAL 8000 product range.

### 4.1. Product environment

- The device is intended for indoor use only and must not be used outdoors.
- The device is intended to be used at between -5°C to +40°C and 15-90% non-condensing relative humidity. If the device is stored in an environment outside these limits, the device must be acclimatised for up to 4 hours to achieve an approved temperature before use.

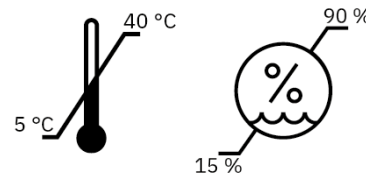

- The device must not be used at altitudes greater than 2000 m above sea level.
- The device must not be exposed to extreme cold or heat, prolonged sunlight or other radiation.
- The device must not be exposed to water, liquids or chemicals to any extent other than that specified in the care information in Section 3. Caring for the device.

## 5. Configurations and settings

It describes the device's models, options when configuring the device, and information about setting and adjusting the device's functions. For dimensions and performance, see 7. Technical information.

The device is available in two fixed models. The basic design of each model is described below, see 5.2. Basic design. The configuration of the models can be adapted to the needs of different clinicians; for more information please contact Mercado Medic, see 1.1. Contact details.

Data sheets and order forms are found at [www.mercado.se](http://www.mercado.se). There are also instructions for use and device information for all Mercado Medic devices.

### 5.1. Required level of competence for setting and adjusting

The device should be configured for each individual patient in order to acquire the correct position for accurate X-ray images. Only the operator may makes settings and adjustments.

## 5.2. Basic model

The Device is always supplied with a seat, back rest, armrests, a base with four castors (ø 100 mm as standard), a push bar and foot and hand brake. The device is available in two models, Screening Mammography and Clinical Mammography.

PLEASE NOTE! The basic model of the device may vary depending on the agreement between Mercado Medic and the customer.

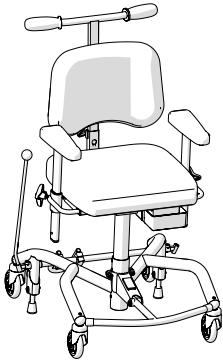
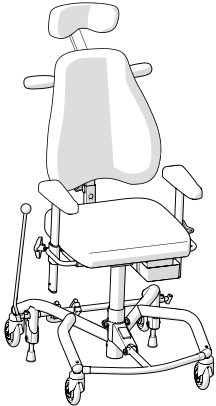
	<b>REAL 8200 PLUS EL 24V Screening Mammography</b>	<b>REAL 8200 PLUS EL 24V Clinical Mammography</b>
		
Height adjustment	Electric height adjustment with wireless remote control	Electric height adjustment with wireless remote control
Seat height	440–720 mm	440–720 mm
Seat	ErgoMedic 440 x 430 mm (as standard)	ErgoMedic 440 x 430 mm (as standard)
Seat tilt	No	Electric
Seat tilt range <sup>1</sup>	0°	-15°/+15°
Folding foot ring	Yes	Yes
Brake	Manual foot and hand brake	Manual foot and hand brake
Castors	100 mm	100 mm
Back support	ErgoMedic 400 x 340 mm	ErgoMedic 420 x 430 cm
Back recliner	Fixed	Electric
Back rest mechanism interval <sup>1</sup>	0°	-23°/+28°
Push bar	Yes	Yes
Armrests	ErgoMedic 250 mm (as standard)	ErgoMedic 250 mm (as standard)
Neck support	No	ErgoMedic Plus 230 x 80 mm
Fabrics	Faux leather (For available colour, see <a href="http://www.mercado.se">www.mercado.se</a> )	Faux leather (For available colour, see <a href="http://www.mercado.se">www.mercado.se</a> )

<sup>1</sup> Negative angle (-) refers to forward tilt and positive angle (+) refers to backward tilt.

### 5.3. Electrical functions

The product is equipped with electric height adjustment. The REAL 8200 PLUS EL 24V Clinical Mammography model is also equipped with an electric seat tilt and electric back rest mechanism. Electrical functions are adjusted via wireless remote control.

#### Remote control

The remote control comes in models with 1 or 4 functions. The 1-function is intended to only control raising and lowering. The 4-function model can control multiple functions. The remote control also has a button lock function (see Figure 5.4).

#### Seat height

Buttons on the top left-hand keypad (see Figure 5.1).

Adjustment:

1. Press up for upward movement.
2. Press down for downward movement.

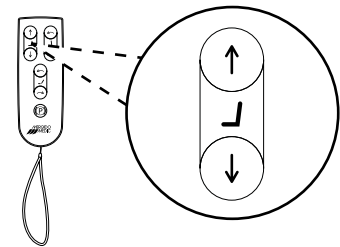

Figure 5.1. Button for adjusting seat height.

#### Seat tilt

Buttons on the upper right-hand keypad, see Figure 5.2.

Adjustment:

1. Press up for forward seat tilt.
2. Press down for backward seat tilt.

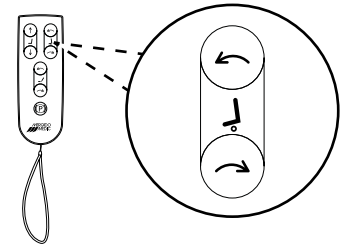

Figure 5.2. Button for adjusting seat tilt.

#### Back recliner

Buttons on the lower keypad in the middle, see Figure 5.3.

Adjustment:

1. Press up to move the back recliner forwards.
2. Press down to move the back recliner backwards.

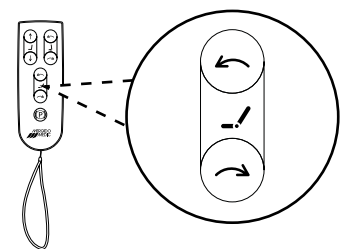

Figure 5.3. Button for adjusting back recliner.

**Button lock**

Activating and deactivating the button lock:

1. To activate the button lock, press and hold both of the directional buttons of the relevant function for at least three seconds.
2. To deactivate the button lock, press and hold both of the directional buttons of the relevant function again for at least three seconds.

PLEASE NOTE! The button lock only locks and unlocks the function that has locked buttons. To lock multiple functions, each function must be locked separately.

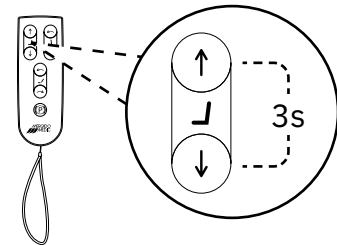

Figure 5.4. Button for activation and deactivation of button lock.

**5.4. Seat**

Seats are available in the ErgoMedic model.

The fabric for seats is in faux leather. Further details about fabrics and available colours, please visit our website [www.mercado.se](http://www.mercado.se).

**ErgoMedic**

ErgoMedic is a flat seat with seat indentation and additional support under the thighs (see Figure 5.5).

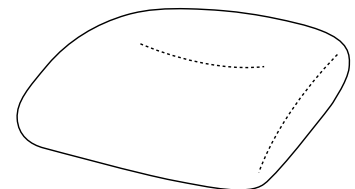

Figure 5.5. ErgoMedic seat.

**5.5. Back support**

Back rests are available in the ErgoMedic model.

The fabric for back rests is in faux leather. Further details about fabrics and available colours, please visit our website [www.mercado.se](http://www.mercado.se).

**ErgoMedic**

ErgoMedic is a lightly cupped back rest, see Figure 5.6. The back rest is available in size 400 x 340 mm for the REAL 8200 PLUS EL 24V Screening Mammography model and 420 x 430 mm for the REAL 8200 PLUS EL 24V Clinical Mammography model.

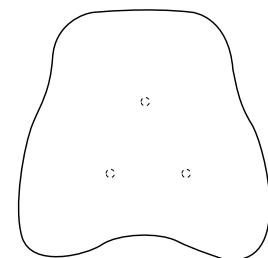

Figure 5.6. ErgoMedic backrest.



## 5.6. Backrest mechanism

The REAL 8200 PLUS EL 24V Screening Mammography model is equipped with fixed back mechanism with a push bar. For the REAL 8200 PLUS EL 24V Clinical Mammography model, adjustment of the back rest mechanism is available as an electrical function, see 5.3. Electrical functions.

### Fixed back mechanism with high back with push bar

The back rest can be adjusted at an angle with the back mechanism, see Figure 5.7. The back rest mechanism has a fixed angle.

Setting the angle of the backrest:

1. Loosen the handle and adjust to the desired angle.
2. Tighten the handle.

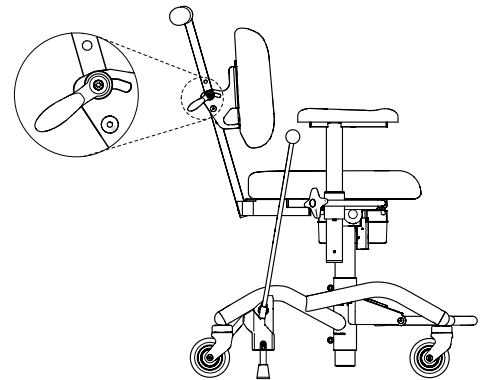

Figure 5.7. Fixed back rest mechanism with high back with push bar.

## 5.7. Arm rest cushion

Armrest panels are available in the ErgoMedic model.

Armrest panel fabric is available in faux leather. Further details about fabrics and available colours, please visit our website [www.mercado.se](http://www.mercado.se).

### ErgoMedic

The ErgoMedic armrest panel is curved at the back to keep the elbow stable. The front of the armrest panel is shaped to provide a good grip when standing up and transferring, see Figure 5.8. The armrest panel is available in a length of 250 mm.

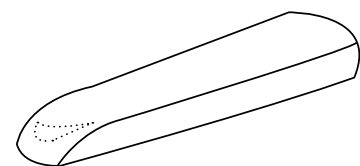

Figure 5.8. ErgoMedic armrest panel.

## 5.8. Armrest mechanism

Armrest mechanism is available in the PLUS armrest model.

On the REAL 8200 PLUS EL 24V Clinical Mammography model, the armrests are mounted to so that they follow the seat when it is tilted, see Figure 5.37.

### PLUS armrest

The height (A) and the width (B) of the PLUS armrest are adjustable, see Figure 5.9.

Height setting:

1. Loosen the knob and adjust to the desired height.
2. Tighten the knob.

PLEASE NOTE! Tighten the knob fully on the PLUS armrest.

Depth setting:

1. Loosen the knob and adjust to the desired width.
2. Tighten the knob securely.

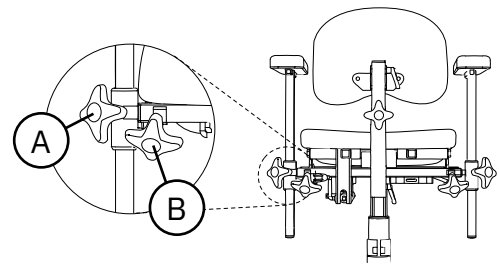

Figure 5.9. PLUS armrest.

## 5.9. Neck support

The REAL 8200 PLUS EL 24V Clinical Mammography model is equipped with an ErgoMedic Plus head rest.

### ErgoMedic Plus

ErgoMedic Plus has a bowled shape and is available in size 230 x 80 mm.

The head rest is adjustable in height (A), depth (B) and angle (C), see Figure 5.10.

Height setting:

1. Loosen the wheels and adjust to the desired height.
2. Tighten the wheels.

Depth setting:

1. Loosen the knobs and adjust to the desired depth.
2. Tighten the knobs.

Adjusting the angle:

1. Loosen the handle and adjust to the desired angle.
2. Tighten the handle.

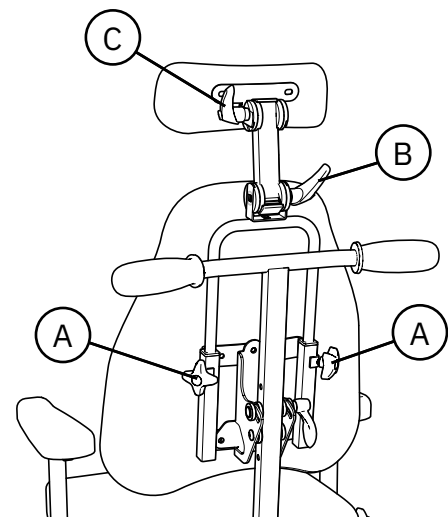

Figure 5.10. Neck support

## 5.10. Base

The device is equipped with a Base 8000 Plus Clinic 48 White. The base is equipped with a foldable foot ring 1/4.

### 8000 Base PLUS Clinic 48 White

The base has two brake legs, and it is reverse braked, see Figure 5.11.

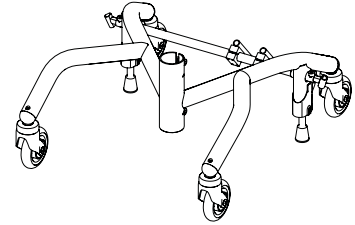

Figure 5.11. Base 8000 Plus Clinic 48 White.

### Folding foot ring 1/4

Foldable foot ring 1/4 is located at the front edge of the base and folds up into one piece, see Figure 5.12.

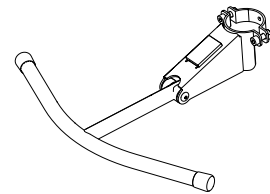

Figure 5.12. Foot ring 1/4.

## 5.11. Manual brake

Two versions of manual braking are available: a foot brake and a brake lever.

### Foot brake

The foot brake is located on the base brake axel, see Figure 5.13.

Activation and deactivation:

1. Push down to the locking position to brake.
2. Press upwards on the underside of the pedal to disengage the brake.

**PLEASE NOTE!** The brake must be in locked mode whenever the patient is sitting down on or getting out of the chair.

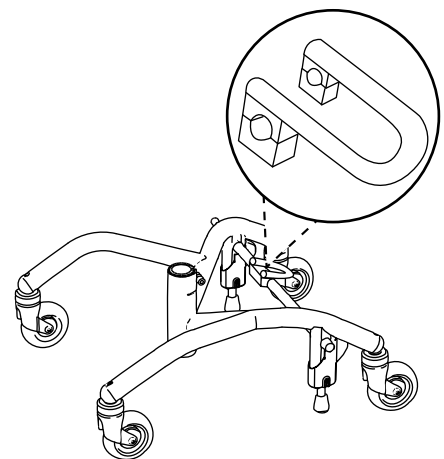

Figure 5.13. Foot brake.

**Brake lever**

The brake lever can be located on the right (A) or left (B) side of the base, see Figure 5.14.

Activation and deactivation:

1. Pull the brake lever to the locking position to brake.
2. Pull the brake lever in the opposite direction to disengage.

Setting the brake lever bracket:

Brake lever brackets are located on the outside of the base at the rear wheels on the right and left sides. In order to brake even when the width of the armrest is fully adjusted outwards, the brake lever brackets can also be adjusted outwards, see Figure 5.15.

1. Loosen the screw on the brake lever bracket with a 6 mm Allen key. Gently pull out the bracket.
2. Attach the screw to the next hole and tighten the screw tightly with the Allen key.

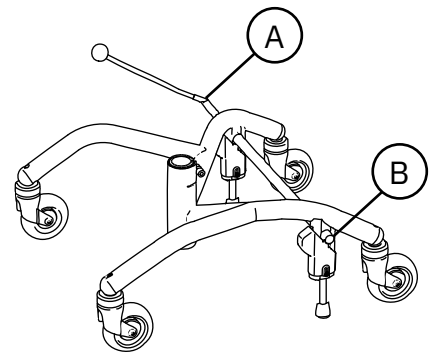

Figure 5.14. Brake lever.

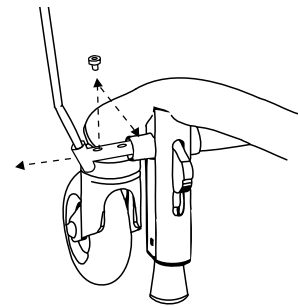

Figure 5.15. Setting the brake lever bracket.

## 5.12. Individual customisation

The device must not be equipped with any accessories or components other than those approved by Mercado Medic. To maintain the CE marking, no individual modifications or changes may be carried out without Mercado Medic's approval. Modifications may be made only by personnel who have completed Mercado Medic's training for servicing and reconditioning.

If the following guidelines are met when individually adapting authorised personnel of an organisation other than Mercado Medic, then Mercado Medic retains device responsibility for the device.

- Padded components such as seats, backrests, armrests and neck supports can be adapted as long as they do not exceed the existing external dimensions of the device.
- The patient's centre of gravity must be maintained over the lifting mechanism.
- Padded parts must be able to withstand the applicable flammability requirements and other environmental requirements. If a third-party seat cushion is used, the device must be fitted with a seat mat in anti-slip material of an equivalent size in order to ensure the safety of the device.
- Surfaces that are loaded with significant vertical forces must not fall outside the area (base) that is formed by the centre points of the castors.

devices that have undergone changes outside of the above guidelines must be verified by Mercado Medic in order for Mercado Medic to continue to retain device liability.

For devices specially adapted by healthcare services, outside Mercado Medic's directive, device liability passes to the healthcare services until the device has been restored to original condition or removed from the market. Mercado Medic will then re-assume device liability in accordance with the CE marking Regulation on Medical Devices (EU) 2017/745, MDR.

For questions regarding customisation, please contact the device Manager at Mercado Medic using the contact details of the head office under Section 1.1. Contact details.

## 6. Important safety information

Our website [www.mercado.se](http://www.mercado.se) has information about any safety notices to the market or recalls of devices and accessories.

### 6.1. Standards met and classification

Mercado Medic's mammography chairs are CE marked in accordance with the Regulation on Medical Devices (EU) 2017/745, MDR, and the Medical Devices Agency's Code of Statutes for Medical Devices LVFS 2003:11. The devices are medical devices as defined in Article 2 of the MDR. The devices are classified as Class 1 non-invasive medical devices in accordance with Regulation 1. The active property of the device variants with electrical functions is not considered to affect the classification.

The devices are tested and approved according to the following standards:

- EN 12182:2012
- IEC 60601-1:2005 + A1:2012
- EN 60601-1-2:2015
- EN 60601-1-11:2015 + A1:2020
- EN 1335-1:2000
- EN 1335-2:2009
- EN 1335-3:2009

The following standards have also been used in the development of the devices:

- EN 1041:2008 + A1:2013
- EN ISO 14971:2020

All textiles on the devices have been tested and approved according to the following fire protection standards:

- EN 1021-1:2014 (ignition source: lit cigarette)
- EN 1021-2:2014 (ignition source: gas flame equivalent to a burning match)

Only the underside of the seat and armrests do not have fire protection as they are wooden. All other surfaces are made of metal or clad in fire protection-rated textiles. Armrests, seats, backrests, etc. have been developed and designed to be free from toxic substances and allergens.

Models with electrical functions are classified according to IEC 60601-1:2005 as a medical device with applied part (Applied Part as defined in standard) of type B associated protection class II with internal power source.

Models with electrical functions meet protection class IP21. The first digit (2) covers contact protection for fingers, etc., preventing access to hazardous parts with fingers or similar. The second digit (1) means vertical drip protection, and so the device can therefore withstand light showers from above.

## 6.2. Warnings



Warning! As a user, you should contact your distributor if device performance deteriorates or changes. A device showing a loss of or change in performance must immediately be taken out of use in order to avoid an accident. The device must not be used again until an authorised technician has examined the device.



Warning! You are not permitted to modify the device yourself. Please contact your distributor if you would prefer individual customisation. If the device is modified, the CE marking no longer applies and Mercado Medic may no longer have full device liability. Modifications may affect the safety of the device and lead to accidents.



Warning! The device may be equipped with long cables or wires that cannot be secured in order for the device to function properly. Cables and wires can pose strangulation risks to small children, for example. Do not leave the device unattended with small children nearby.



Warning! The device is equipped with small parts such as screws that can come loose. Small parts that have come loose can pose a potential choking hazard for children.



Warning! Metal surfaces may become very hot if they are exposed to direct sunlight. Skin contact with hot surfaces can lead to burns. Avoid exposing metal surfaces to direct sunlight.



Warning! Always make sure that the device's brake is applied when the patient sits down and gets up. If the device's brake is not applied, there is a risk that the device will roll away, which could lead to fall injuries.



Warning! Repairs and other technical measures may only be carried out by personnel authorised by Mercado Medic. If this is not followed, the CE marking no longer applies and Mercado Medic may no longer have full device liability.



Warning! The device must not be loaded with loads higher than the maximum user weight. At higher loads, there is a risk that the life of the device will be shortened and components may break. If the device has been subjected to higher loads than intended, authorised personnel should carry out an overall assessment, see 6.3. Expected service life, to ensure that it remains safe to use the device.



Warning! Electric models have a lifting mechanism that can lift the user so high that it could pose a risk. If the patient is unable to get out of the device from its highest position, the seat height must never be higher than the position at which the patient's feet touch the ground.





Warning! Only batteries and chargers from Mercado Medic that have been tested and approved for use with the product may be used with models with electrical functions. If using other chargers or batteries, the CE marking is not applicable and Mercado Medic AB's device liability will cease to be valid for any cases regarding the battery, charging or other electronics.



Warning! The device must not be equipped with any accessories or components other than those approved by Mercado Medic. To maintain the CE marking, no individual modifications or changes may be carried out without Mercado Medic's approval. See section 5.12 if a non-approved component it to be used. individual customisation.



Warning! Do not plug any electrical accessory, other than those customised by Mercado Medic, into the control system's contacts. Non-adapted components are at risk of breaking and in turn injuring the user. See section 5.12 if a non-approved component it to be used. individual customisation.



Warning! Installation, connection or dismantling is not risk-free. If components are handled incorrectly, for example, crushing damage may occur. This type of work may therefore only be carried out by a Mercado Medic authorised technician.



Warning! All parts of the device must be installed and fixed so that there is no risk of small parts coming loose. All cables must be secured with cable ties to the device's structure to minimise the risk of strangulation.

### 6.3. Expected service life

The expected service life of the device is ten years when used in accordance with these instructions for use. The expected service life of the device is calculated from the date of manufacture of the device. The date of manufacture of the device can be found on one of the silver labels on the device's base and is in the format YYYY-MM (year and month), see Figure 6.1. The label also includes serial numbers and an identifier for the device model (UDI-DI).

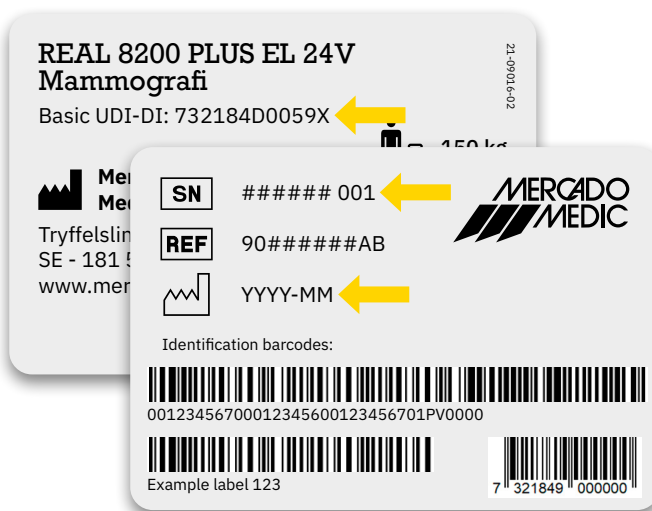

Figure 6.1. Serial number, UDI-DI and date of manufacture on the label.

PLEASE NOTE! If the label indicating the serial number and date of manufacture is damaged or destroyed, contact your distributor first for assistance in identifying the device, see 1.1. Contact details. Once the order number or serial number is identified, contact Mercado Medic for a replacement label.

The expected service life of accessories supplied with a Mercado Medic device is 10 years unless otherwise stated in the accompanying documentation.

The expected service life of the device battery is 5 years when the device is charged in accordance with these instructions for use, see 2.3. Charging.

In order to continue using the product beyond its expected service life, you must make sure that periodic maintenance at intervals no more than two years apart are performed until the device is permanently decommissioned. Maintenance should be carried out according to these instructions for use, see page 8. Servicing and reconditioning, in addition to the overall assessment below.

After the expected service life, Mercado Medic cannot guarantee the suitability and safety of the device, as Mercado Medic has no control over how the device has been used and its wear and tear. After the expected service life, Mercado Medic AB cannot guarantee the provision of spare parts.

#### **Overall assessment**

After the expected service life, it is important to make an overall assessment of the device before continuing to use it. The overall assessment of the device must be carried out by authorised personnel and should, as a minimum, take the following into consideration:

- how the device has been used,
- what condition the device and its components are in,
- whether the device has been reconditioned and serviced,
- when reconditioning and servicing have been carried out,
- what has been remedied on the above occasions,
- and the reason for the above remedial measures.

After the expected service life, periodic maintenance at intervals of a maximum of 2 years shall be carried out according to these instructions for use, see 8. Servicing and reconditioning, in addition to the overall assessment below.

#### **6.4. Reporting of adverse events and incidents**

As a manufacturer of medical devices in the EU, Mercado Medic is obliged to have a system to monitor how our devices work in practical use.

Before our devices are CE-marked and placed on the market, we have taken into account the risks that may be present with them and taken measures to reduce the risks as far as possible. Nevertheless, accidents and incidents can occur when the devices are used. If this happens, it is important that this is reported to both Mercado Medic and the national relevant authority. Use contact details in these instructions for use for reporting, see 1.1. Contact details. Feel free to use email to enable faster handling.

## 7. Technical information

This section describes the dimensions and performance of the device, as well as symbols that appear on the device.



Warning! Repairs and other technical measures may only be carried out by personnel authorised by Mercado Medic. If this is not followed, the CE marking no longer applies and Mercado Medic may no longer have full device liability.

### User weight

Model	Max
REAL 8200 PLUS EL 24V Screening Mammography	150 kg
REAL 8200 PLUS EL 24V Clinical Mammography	150 kg



Warning! The device must not be loaded with loads higher than the maximum user weight. At higher loads, there is a risk that the life of the device will be shortened and components may break. If the device has been subjected to higher loads than intended, authorised personnel should carry out an overall assessment, see 6.3 Expected service life, to ensure that it remains safe to use the device.

### Device characteristics for all models

	REAL 8200 PLUS EL 24V Screening Mammography	REAL 8200 PLUS EL 24V Clinical Mammography
Width <sup>1</sup>	480 mm	480 mm
Length	530 mm	530 mm
Total height <sup>2</sup>	950–1,230 mm	970–1250 mm
Seat height	440–720 mm	440–720 mm
Seat width	440 mm	440 mm
Seat depth	430 mm	430 mm
Seat tilt <sup>3</sup>	0°	-15°/+15°
Backrest height	340 mm	430 mm
Backrest width	400 mm	420 mm
Back rest mechanism <sup>3</sup>	Fixed	-23°/+28°
Castors	Ø100 mm	Ø100 mm
Weight	23 kg	26 kg
Max. incline with brake applied <sup>4</sup>	5°	5°

1 Depending on the seat width and the adjustment of the armrests, the device may become wider.

2 Measured up to the top of the push bar in the lowest position possible.

3 Negative angle (-) refers to forward tilt and positive angle (+) refers to backward tilt.

4 Applicable in all directions.

**Device characteristics for all electric models**

Battery	805320 Battery pack 2.6Ah 24V f RCB10+L
Battery type	Sealed valve-controlled lead acid battery
Voltage, battery pack	24V (2 x series coupled 12V batteries)
Charger	805265 Battery charger 9000 30V for work chairs 24V 1.5G

On a full charge with a high electrical lifting mechanism, you can raise the chair fully up/down a maximum of 180 times with a load of 80 kg, or up to 135 times with a load of 150 kg.

The electrical functions, except raising and lowering, may be used for max. 10% of the time (max. 2 mins/20 mins). The electronics measure activity and shut down the electrical functions if this limit is exceeded. When the total time of use in the last 20 minutes is less than 2 minutes, the features are automatically re-activated.

### 7.1. Symbols

The following symbols are used on the device controls, markings or in these instructions for use. For an overview of the location of symbols, see Figures 7.1–7.3.

#### No. Electric controls and control box

1		Seat height up/down
2		Seat tilt forwards/backwards
3		Back recliner forwards/backwards
4		Brake activation/deactivation (not compatible with this device)
5		Charging socket
6		Input for control
7		Connection for electric lifting mechanism
8		Seat tilt connection
9		Connection for back recliner
10		Brake connection (not compatible with this device)
11		Read the instructions for use before use

#### No. Labelling and instructions for use

12		Warning
13		Protect from moisture
14		Handle with care
15		This side up
16		Permitted temperature
17		Permitted relative humidity

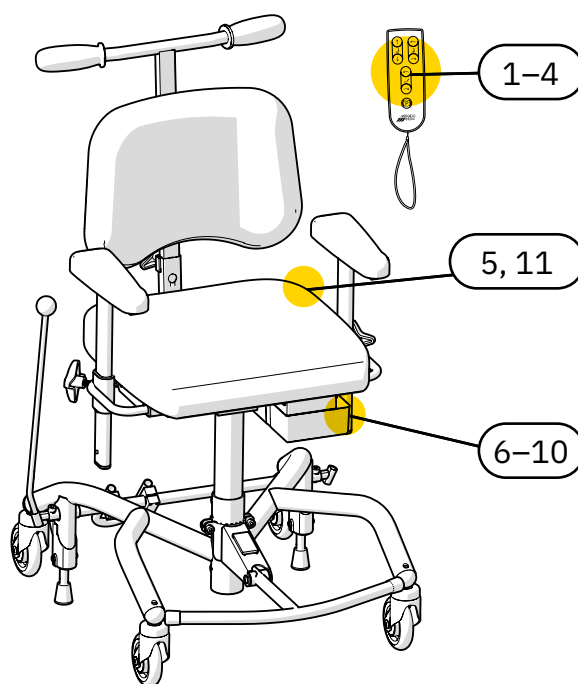

















Figure 7.1. Overview of symbols on the device's controls.

**No. Labelling and instructions for use**

18		Permitted altitude
19		For indoor use only
20		Maximum user weight
21		Date of manufacture
22		Manufacturer
23		Medical device
24		Serial number
25		CE mark showing the device's conformity with the European regulatory framework
26		Device classified as Type B applied part according to IEC 60601-1:2005
27		Electrical components must be disposed of at a special collection point
28		The device is part of a recycling system
29		Component weight exceeds 10 kg
30		Operating cycle
31		Distributor
32		Directory number

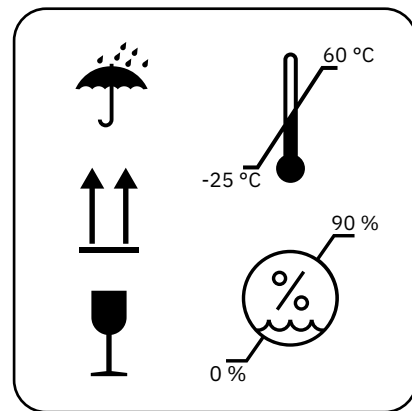

Figure 7.2. Overview of symbols on packaging. Symbols 13–17.

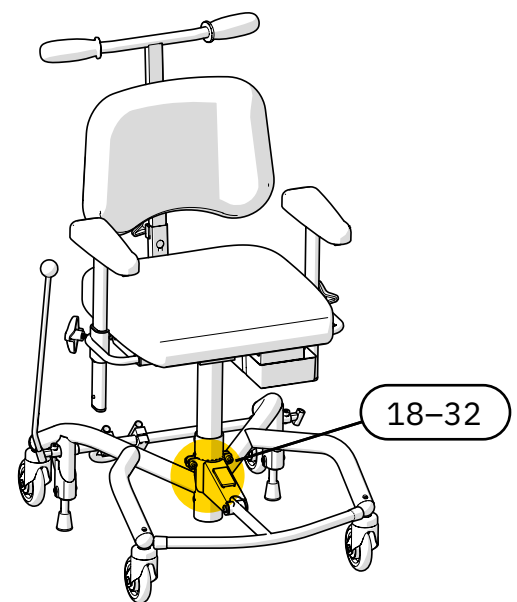

Figure 7.3. Overview of symbols on marking.

## 8. Servicing & reconditioning

This section describes the inspection and troubleshooting of the device, information about battery replacement and instructions for reconditioning the device. The troubleshooting guide is aimed at all users of the device, and the section is otherwise aimed at those who handle these parts of the device lifecycle professionally.

PLEASE NOTE! Reconditioning, servicing or maintenance work on the device is not permitted while the patient is sitting in it.

### Inspection during service

A thorough visual inspection must be performed of the device's main components in order to guarantee the patient's safety. The main components of the device include base, brake, lifting mechanism, seat frame, back recliner and armrest mechanism. The inspection must include welds, lockable functions and settings.

When checking the PLUS base, always inspect the weld between the base's front and rear legs. Any indication of cracks in the material or paint in this area should be regarded as reason to replace the base, or the device. Make sure there is good lighting and preferably use a magnifying glass, as small cracks can be difficult to detect on black-painted bases.

In case of reduced braking action, check both the stability of the base and the condition of the brake rubber. If the device is not resting on all four wheels in the unbraked position, the device must be withdrawn from service immediately. Check the balance of the base in several locations and in several directions to exclude any influence from the floor.



Warning! Repairs and other technical measures may only be carried out by personnel authorised by Mercado Medic. If this is not followed, the CE marking no longer applies and Mercado Medic may no longer have full device liability.



Warning! As a user, you should contact your distributor if device performance deteriorates or changes. A device showing a loss of or change in performance must immediately be taken out of use in order to avoid an accident. The device must not be used again until an authorised technician has examined the device.

## 8.1. Troubleshooting guide

If none of the following actions address the problem that has occurred, service may be required. Contact your distributor or get in touch with Mercado Medic, see 1.1. Contact details.

### Troubleshooting for electrical functions

Symptom	Cause	Action
The control box emits an audible signal.	The device has a low or critical battery level.	Charge the device, see 2.3. Charging.
The electrical functions do not work.	The work cycle has been exceeded, see 7. Technical information. If the limit is exceeded, all electrical functions are switched off, except for electrical height adjustment. The features cannot be used again until the system has recovered.	The device will start working again once the system has recovered. This takes up to 20 minutes.
The electrical functions do not work.	The button lock has been activated.	To enable or disable the button lock for a function, press and hold both of the directional buttons of the relevant function for at least three seconds. Each function has a separate button lock.
The electrical functions do not work.	An internal error has occurred.	The system will be reset automatically after 10 seconds. If the error has been resolved, then all channels will be unlocked and the warning light will be switched off.
The electrical functions do not work.	The battery needs to be charged or activated. If the device has been unused for 7 days or more, the battery will be automatically disconnected to maximise service life.	Charge or activate the battery by connecting the charger. It is recommended to always charge fully when doing this. For activation only, it is enough that the charger is connected for about 5 seconds.
The electrical functions do not work.	The internal batteries of the device are discharged or defective.	Charge the device, see 2.3. Charging. If charging does not fix the problem, a replacement battery is needed, see 8.2. Battery replacement.



<b>Symptom</b>	<b>Cause</b>	<b>Action</b>
Electrical functions do not work if a button on the wireless remote control is pressed.	The batteries in the wireless remote control are empty or defective.	Replace the batteries in the wireless remote control, see 8.2. Battery replacement.
Electrical functions do not work if a button on the wireless remote control is pressed.	The remote control and IR receiver are not properly paired.	Pair the remote control and receiver. See assembly instructions for Remote control IR 24V.
The electrical functions do not work.	Defective actuator.	If the above measures have not resolved the problem, this may be because the actuator is defective and needs to be replaced.

### Troubleshooting mechanical components

<b>Symptom</b>	<b>Cause</b>	<b>Action</b>
The seat slips in the direction of rotation.	Gap in the lifting mechanism.	Replace the lifting mechanism.
Noise in the electric lifting mechanism.	Worn bearings.	Replace the electric lifting mechanism.
Noise in the castors.	Worn bearings.	Replace the castors.
The device does not move smoothly.	Accumulation of hair and debris in castors.	Clean the castors, see 3. Caring for the device. Alternatively, replace the castors.
The device does not move smoothly.	Worn bearings or uneven wheel track.	Replace the castors.
The device does not brake satisfactorily.	Accumulation of dirt and dust under brake feet.	Clean the underside of the brake feet, see 3. Caring for the device.
The device does not brake satisfactorily.	The rubber brake feet have solidified over time.	Replace the brake feet <sup>1</sup> .
The device does not brake satisfactorily.	The base is warped and needs to be replaced.	Replace the base and report this event to Mercado Medic. See 1.1. Contact details.

<sup>1</sup> The brakes must be checked on a regular basis, see 6. Important safety information.

## 8.2. Battery replacement



Warning! Repairs and other technical measures may only be carried out by personnel authorised by Mercado Medic. If this is not followed, the CE marking no longer applies and Mercado Medic may no longer have full device liability.

The internal batteries of the device can be replaced. Both batteries in the battery pack must be replaced at the same time. For instructions, see installation instructions 'Battery replacement 24V'.

To replace batteries in remote control, see assembly instructions 'Remote control IR 24V 1G'.

### 8.3. Reconditioning and periodic maintenance

No periodic maintenance is required during the expected service life of the device. In order to continue using the device beyond its expected service life, periodic maintenance at a maximum interval of two years apart must be performed until the device is permanently decommissioned.

Reconditioning in these instructions for use does not refer to a full restoration or complete refurbishment in the sense referred to in the Medical Devices Regulation (EU) 2017/745, MDR, with a view to putting the device on the market again with a renewed expected service life. Reconditioning in these instructions for use aims instead at a more comprehensive review and service of the device, but where serial numbers are retained and expected service life remains unaffected.

#### Inspection during reconditioning

Reconditioning must include a thorough visual inspection of the device's main components in order to guarantee patient safety. The main components of the device include base, brake, lifting mechanism, seat frame, back recliner and armrest mechanism. The inspection must include welds, lockable functions and settings.

When checking the PLUS base, always inspect the weld between the base's front and rear legs. Any indication of cracks in the material or paint in this area should be regarded as reason to replace the base, or the device. Make sure there is good lighting and preferably use a magnifying glass, as small cracks can be difficult to detect on black-painted bases.

In case of reduced braking action, check both the stability of the base and the condition of the brake rubber. If the device is not resting on all four wheels in the unbraked position, the device must be withdrawn from service immediately. Check the balance of the base in several locations and in several directions to exclude any influence from the floor.

#### Replacement of components

On [www.mercado.se](http://www.mercado.se) there are various forms of substrate for changing components, such as exploded diagrams, assembly instructions, connection guides and digital item search. Installation instructions can also be used to disassemble the device's components. For accessories and spare parts please visit our webshop <https://shop.mercado.se/>.



Warning! Installation, connection or dismantling is not risk-free. If components are handled incorrectly, for example, crushing damage may occur. This type of work may therefore only be carried out by a Mercado Medic authorised technician.



Warning! All parts of the device must be installed and fixed so that there is no risk of small parts coming loose. All cables must be secured with cable ties to the device's structure to minimise the risk of strangulation.

#### Long-term storage of batteries

During longer periods of storage, the battery is automatically disconnected after seven days. The battery may also be forced into unplugged mode by plugging a 9V power supply (part number 804823) into the charging socket and waiting for at least 5 seconds before disconnecting the power supply. When the battery is disconnected, it must be charged every four months in order to retain its functionality, see 2.3. Charging.

If these charging instructions are followed, the battery will maintain sufficient capacity for 5 years.

To reconnect the battery to the system again, connect the battery charger to the charging outlet and wall socket. Wait at

least five seconds before disconnecting the battery charger. The battery is now activated again and the system is ready for use. We recommend leaving the charger in place and fully charging the battery after the device has been stored with the battery in a disconnected state.

**Reconditioning instructions**

Do not use high pressure washers when cleaning the device. For instructions on everyday cleaning, see 3. Caring for the device.

The following points should be performed during reconditioning to ensure patient safety:

<b>ID</b>	<b>Area</b>	<b>Reconditioning instructions</b>
<b>1 Cleaning</b>		
1.1	Mechanisms	Clean mechanical parts (not the actuator) using a clean, damp cloth with mild detergent (pH 7-12), surface disinfectant or use a steam cleaner (max. 8 bar).  PLEASE NOTE! Do not wash the device with water or other liquids and chemicals.
1.2	Electronics and cables	Remove dust with a dry cloth.
1.3	Controls and remote control	Wipe the controls and the remote control with a cloth slightly dampened with disinfectant. This is so as not to pass on any possible infection.
1.4	Actuator and lifting mechanism	Moving parts are lubricated and should therefore not be cleaned. For lifting mechanisms, see special instructions under section 3.
1.5	Upholstery	We recommend dismantling and discarding all upholstery. Wash any covers according to the washing instructions.
1.6	Castors	Clear the castors of hair and dust.
<b>2 Electrical components</b>		
2.1	Electronics	Start by charging the device for at least 5 seconds to activate the electronics. Check the electronics and all electrical functions. Check for physical damage to the control box and any contact box.
2.2	Charger	Check that the charger is working and that the casing and cables are undamaged.
2.3	Controls	Make sure that the control buttons and remote control are working and have no damage to the casing or cables.

<b>ID</b>	<b>Area</b>	<b>Reconditioning instructions</b>
2.4	Contacts	Check that cables and connectors are intact and properly secured. Ensure that all colour markings on contacts are still in place. Supplement if necessary. Check that there is no risk of crushing cables and connectors, and that all cables are fastened with cable ties.
2.5	Batteries	Check the batteries' voltage and that there is not too great a difference between the batteries' charge. A large difference in charging may indicate that a battery cell is defective. See installation instructions 'Battery replacement 24V'. Keep in mind that the life expectancy of the batteries is 5 years when maintained according to these instructions for use. This means that it may be time to replace them depending on when the reconditioning is complete and what remedial actions have been taken on the device in the past.
2.6	Electric seat tilt	Check that the actuator is not visibly damaged. Check the function of the actuator's moving parts. Check that all locking screws are tightened to avoid any play in the end position.
2.7	Electric back recliner	Check that the actuator is not visibly damaged. Check the function of the actuator's moving parts. Check that all locking screws are tightened to avoid any play in the end position.
<b>3 Electric lifting mechanism</b>		
3.1	Noise	Listen for noise in the lifting mechanism. Replace the lifting mechanism in case of noise. Load the device and check that the lifting mechanism does not slip when starting from the bottom position. Defective lifting mechanisms can be sent to Mercado Medic for repair.
3.2	Rotation lock	Make sure that the lifting mechanism does not have any play when rotating or loading from side to side. Replace the lifting mechanism in case of play. Defective lifting mechanisms can be sent to Mercado Medic for repair.
3.3	Lifting columns	Raise the lifting mechanism to the highest position. Wipe the lifting column of dust and dirt with a dry cloth. Then lubricate the lifting column using a thin layer of Teflon or silicone-based grease.
3.4	Attachment	Check that the seat is facing straight ahead relative to the base. Check that the lifting mechanism attachments to the seat frame are correctly assembled and tightened. Replace screws that have damaged key handles or threads.
3.5	Cabling	Inspect cables for any signs of wear, pinching or crushing.

<b>ID</b>	<b>Area</b>	<b>Reconditioning instructions</b>
<b>4 Base</b>		
4.1	Welds	Check all welds carefully for signs of cracks, corrosion and movement. Make sure there is good lighting and preferably use a magnifying glass, as small cracks can be difficult to detect on black-painted bases. Make sure the base is stable. Fill in any varnish damage with touch-up paint to avoid corrosion.
4.2	Bolted joints	Check and tighten all screw joints. Replace screws that have damaged key handles or threads.
<b>5 Brakes</b>		
5.1	Function	Replace the brake feet. Check that the brake is working properly.
5.2	Plastic plugs	Check that guide bushings and plastic plugs are properly secured. Replace worn or damaged parts.
5.3	Pinch protection	Check that any pinch protection is securely mounted. If there is no pinch protection on the brake legs, it is recommended that this be installed before the device is put back into service.
<b>6 Castors</b>		
6.1	Function	Check castors and jumpers for wear or play. Wear or play may indicate defective bearings. Check that the castors rotate well and the housings rotate. Replace worn or damaged parts.
6.2	Attachment	Check that the castors' screws are intact and tightened. Replace screws that have damaged key handles or threads.
<b>7 Seat frame</b>		
7.1	Mechanics	Carefully check all welded parts for cracks and paint damage. In particular, check around the mounting of actuators for the seat tilt and at the holes for mounting leg supports, as these areas are particularly subject to load. Ensure good lighting and preferably use a magnifying glass, as small cracks can be difficult to detect on black lacquered structures. Fill in any varnish damage with touch-up paint to avoid corrosion.
7.2	Bolted joints	Check and tighten all screw joints. Replace screws that have damaged key handles or threads.
7.3	Plastic plugs	Check that guide bushings and plastic plugs are properly secured. Replace worn or damaged parts.
7.4	Controls	Make sure that all knobs and handles on the seat frame are working and that they lock correctly.

<b>ID</b>	<b>Area</b>	<b>Reconditioning instructions</b>
<b>8 Back rest mechanism</b>		
8.1	Mechanics	Check and replace any worn parts, carefully inspect for cracks in welds as they may have been heavily loaded for a long time. Ensure good lighting and preferably use a magnifying glass, as small cracks can be difficult to detect on black lacquered structures. Check that the moving parts work properly.
8.2	Attachment	Make sure that all screws, knobs and handles are easy to move and lock properly. Check that the spring button clips are working flawlessly.
8.3	Plastic plugs	Check that guide bushings and plastic plugs are properly secured. Replace worn or damaged parts.
<b>9 Armrests</b>		
9.1	U-bars	Carefully check the U-bars for cracks and paint damage. Check especially around welds and grooves for the locking, as these areas are particularly subject to load. Ensure good lighting and preferably use a magnifying glass, as small cracks can be difficult to detect on black lacquered structures. Fill in any varnish damage with touch-up paint to avoid corrosion.
9.2	Function	Check and replace any worn parts. Test that locking and function in moving parts are working properly. Check that knobs and screws are working and have no damage to threads or grip surfaces.
9.3	Plastic plugs	Check that guide bushings and plastic plugs are properly secured. Replace worn or damaged parts.
9.4	Armrest mechanics	Check all welds and that there is no damage to mechanical parts that may impair or weaken the structure. Ensure good lighting and preferably use a magnifying glass, as small cracks can be difficult to detect on black lacquered structures. Fill in any varnish damage with touch-up paint to avoid corrosion.
<b>10 Accessories</b>		
10.1	Mechanics	Check all welds and that there is no damage to mechanical parts that may impair or weaken the structure. Ensure good lighting and preferably use a magnifying glass, as small cracks can be difficult to detect on black lacquered structures.
10.2	Function	Check and replace any worn parts. Check that the locking and function of moving parts works properly.

ID	Area	Reconditioning instructions
<b>11 Final inspection</b>		
11.1	Final inspection	Test all functions of the device. Check that all settings, electrical functions and brakes are working properly. Check that the castors are working properly and that all four wheels are in contact with the surface.
11.2	Battery sleep mode	If electrical models are to be stocked, the battery can be put into sleep mode with the intended 9V adapter, see 8.3. Reconditioning and periodic maintenance, Long-term storage of batteries.



## 9. Instructions for destruction

Devices permanently decommissioned must be dismantled and sorted in a correct and safe manner. At the website [www.mercado.se](http://www.mercado.se) there are installation instructions that can also be used to dismantle the device's components. The components should then be discarded in the relevant manner, see 9.1. Recycling sorting.



Warning! Installation, connection or dismantling is not risk-free. If components are handled incorrectly, for example, crushing damage may occur. This type of work may therefore only be carried out by a Mercado Medic authorised technician.

### 9.1. Recycling

Instructions for recycling of components.

#### Metal

- Armrest mechanism
- Backrest mechanism
- Neck support mechanism
- Leg support
- Base
- Seat frame
- Actuator
- Lifting mechanism
- Other metal parts in devices sold by Mercado Medic

#### Electronics

- Cabling
- Control box (batteries to be dismantled and recycled separately)
- Contact box
- Remote control

#### Lead battery

- Batteries (discarded batteries should always be taken to environmental recycling centres)

#### Combustible

- Seat
- Backrest
- Neck support
- Armrests
- Other padded parts sold by Mercado Medic





