

# INSTRUCTIONS FOR USE

for medical electric wheelchairs in the  
REAL 6100 PLUS device range

Instructions for use and care



UK

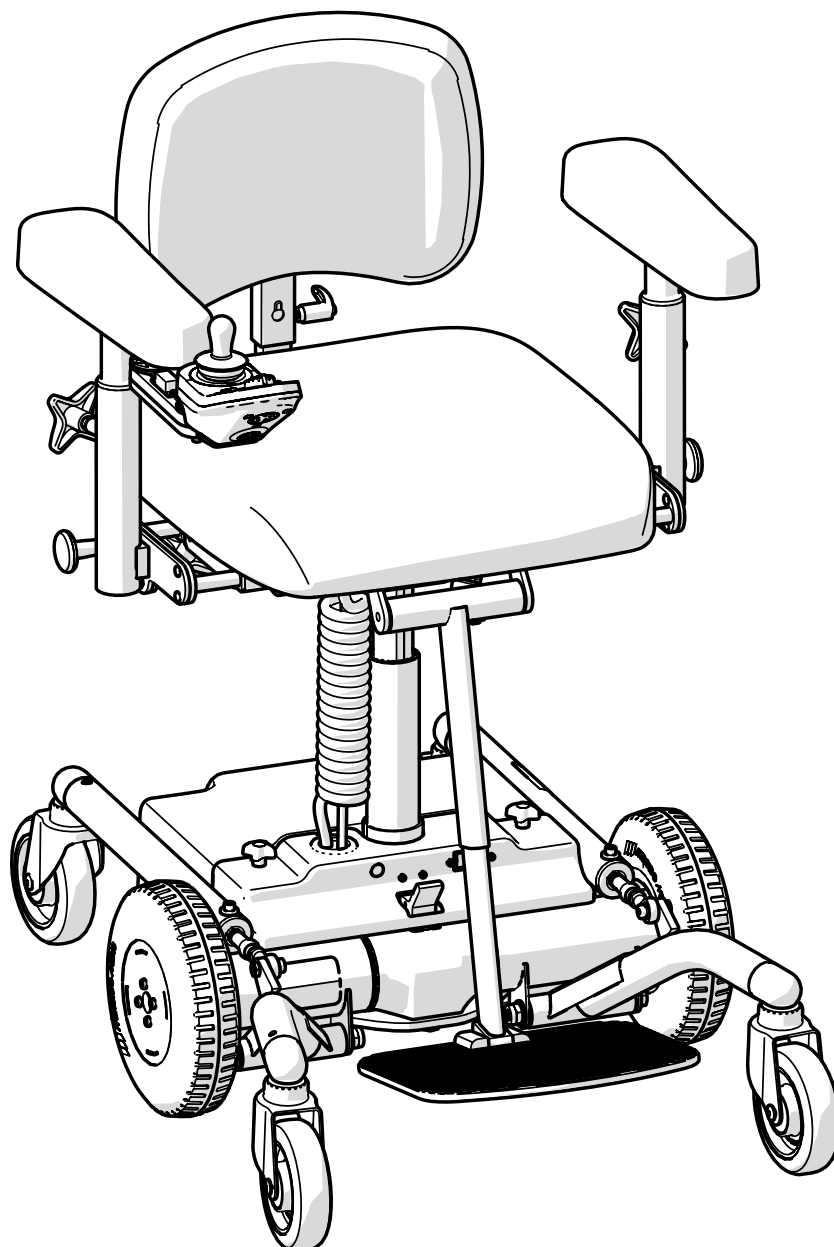

[Space for device label with  
serial number]

# Table of contents

## User information

- 1. Introduction ..... 4
  - 1.1. Contact details ..... 5
  - 1.2. Warranty ..... 5
- 2. Getting started ..... 6
  - 2.1. Before use ..... 6
  - 2.2. Driving and electric height adjustment ..... 9
  - 2.3. Charging ..... 10
  - 2.4. Transferring and moving ..... 11
- 3. Caring for the device ..... 13
  - 3.1. Padded parts ..... 13
  - 3.2. Castors and brake feet ..... 13
  - 3.3. Other parts ..... 13
  - 3.4. Transport and storage ..... 14

## Device information

- 4. intended use ..... 16
  - 4.1. Operating environment ..... 16
- 5. Configurations and settings ..... 17
  - 5.1. Required level of competence for setting and adjusting ..... 17
  - 5.2. Basic design ..... 18
  - 5.3. Control unit ..... 18
  - 5.4. Electric seat functions ..... 27
  - 5.5. Seat ..... 31
  - 5.6. Manual seat tilt ..... 32
  - 5.7. Coxit mechanism ..... 33
  - 5.8. Backrest ..... 34
  - 5.9. Manual backrest mechanism ..... 36
  - 5.10. Armrest panel ..... 38

- 5.11. Armrest mechanism ..... 39
- 5.12. Leg support ..... 41
- 5.13. Chassis ..... 44
- 5.14. Individual adaptation ..... 46
- 6. Important safety information ..... 48
  - 6.1. Standards met and classification ... 48
  - 6.2. Warnings ..... 48
  - 6.3. Expected service life ..... 50
  - 6.4. Reporting of adverse events and incidents ..... 51

## Service manual

- 7. Technical information ..... 52
  - 7.1. Programming the device ..... 54
  - 7.2. Symbols ..... 57
- 8. Servicing & reconditioning ..... 61
  - 8.1. Troubleshooting guide ..... 62
  - 8.2. Battery replacement ..... 66
  - 8.3. Reconditioning and periodic maintenance ..... 67
- 9. Instructions for destruction ..... 74
  - 9.1. Recycling ..... 74

# 1. Introduction

Thank you for choosing Mercado Medic as the supplier of this device. By choosing a REAL chair, you get to learn about a 50-year history of developing medical devices with high function, safety, quality and flexibility. We manufacture all our different medical chairs under our own management in Sweden.

Mercado Medic is certified to ISO 13485, ISO 9001 and ISO 14001, and complies with applicable labour and environmental legislation.

We reserve the right to make changes to this manual and its contents.

Sufficient competence in the safe use of this device is achieved by carefully reading through these instructions for use before using the device for the first time.

**PDF versions of our instructions for use with zoom options are always available in their most current version on our website [www.mercado.se](http://www.mercado.se).**



## 1.1. Contact details

### Manufacturer

Street address: Mercado Medic AB,  
Tryffelslingan 14, SE-181 57 Lidingö, Sweden

Postal address: Mercado Medic AB,  
Box 1074, SE-181 22 Lidingö, Sweden  
Telephone: +46 (0)8 555 143 00  
Email: [info@mercado.se](mailto:info@mercado.se)  
Website: [www.mercado.se](http://www.mercado.se)

### Servicing and technical support

Telephone: +46 (0)8 555 143 08  
Email: [service@mercado.se](mailto:service@mercado.se)

To report warranty claims, adverse events and incidents or other feedback please use the form at [www.mercado.se/en/support](http://www.mercado.se/en/support).

### Distributor

Responsible person: Henrik Sellberg

Mercado UK Ltd  
Repton House, Bretby Business Park,  
Ashby Road  
DE15 0YZ Burton on Trent  
United kingdom

+44 (0)3330 033666  
[info@mercado-medic.co.uk](mailto:info@mercado-medic.co.uk)  
[www.mercado-medic.co.uk](http://www.mercado-medic.co.uk)

Space for additional distributor contact details:

-----  
-----  
-----  
-----

## 1.2. Warranty

All components of Mercado Medic's devices are covered by warranty, under the time periods and general terms and conditions set out below, unless other specific periods and conditions are agreed in writing between Mercado Medic and the contracting customer in connection with major procurements.

As a user, you should contact your prescriber, assistive technology centre or distributor if you experience problems with the device. Distributors in turn should contact Mercado Medic using the contact details available under Section 1.1. Contact details.

### Warranty periods

- Metal structures: 3 years.
- Electric lifting mechanism: 2 years.
- Other components (e.g. wheels, batteries, padded parts): 1 year.

### General terms and conditions

The warranty does not cover:

- Damage or condition considered to be normal wear and tear.
- Damage caused by negligence or misuse.
- Spare parts, components or accessories not sold by Mercado Medic.
- Adjustments to the device made by unauthorised service technicians.
- Components previously fitted to devices other than the item in question.
- Bleaching or natural variations in the colours of fabrics, synthetic leather and natural leather.

## 2. Getting started

This section is primarily aimed at you as a user of the device. It describes how to prepare the device for use, use driving functions, adjust seat height, charge the product, and how to create good conditions during movement. For care instructions, see 3. Caring for the device.

If you have any questions about your device or if something unexpected has happened, please first contact your prescriber or dealer. You can find up-to-date contact details in Section 1.1. Contact details. You are also welcome to contact us at Mercado Medic.

### 2.1. Before use

The device is always delivered with a seat, a back rest, armrests, leg supports and electric height adjustment. Upon delivery from Mercado Medic, the back rest is not yet mounted. This should always be installed before the device is first used.

#### Backrest mechanism

Place the back rest support post in the back rest mechanism (B) and set the desired height level, see Figure 2.1. Tighten all levers (A). The image shows one of several back mechanisms available for Mercado Medic devices. Other back mechanisms are mounted in the same way, although the appearance may differ from that in the image.

#### Armrests

Loosen the armrest levers (C) and set the desired height and width levels, see Figure 2.1. Tighten all controls (B). Make sure the knob clicks into the locking position when the armrest is lowered. If the knob does not click in position, rotate the knob until it clicks firmly.

#### Neck support

If the device is supplied with a headrest, insert the head rest mechanism into the back rest bracket (C) and set the desired height level, see Figure 2.1. Tighten all controls (C).

#### Chassis

Check that the circuit breaker is in the "ON" (D) position and that the brake activation lever is in the "ON" (E) position, see Figure 2.1.

#### Battery

The initial use, the battery must be charged for 12 hours. For other charging instructions, see 2.3. Charging.

#### Control unit

At start-up, check the control unit by checking the following steps:

1. Turn on the main switch (F), see Figure 2.1.
2. Check that the battery level indicator is at least showing a yellow mark (G). Charge the device if the indicator is showing a red marking. See 2.3. Charging.
3. Make sure the light on the main switch (F) is green.

A flashing red light on the main switch will signal there is an error. The number of flashes indicates the fault that has occurred. For more information, see 8.1. Troubleshooting guide. Try restating the device if an error is signalled.. If the error persists, contact your prescriber or distributor, see 1.1. Contact details.

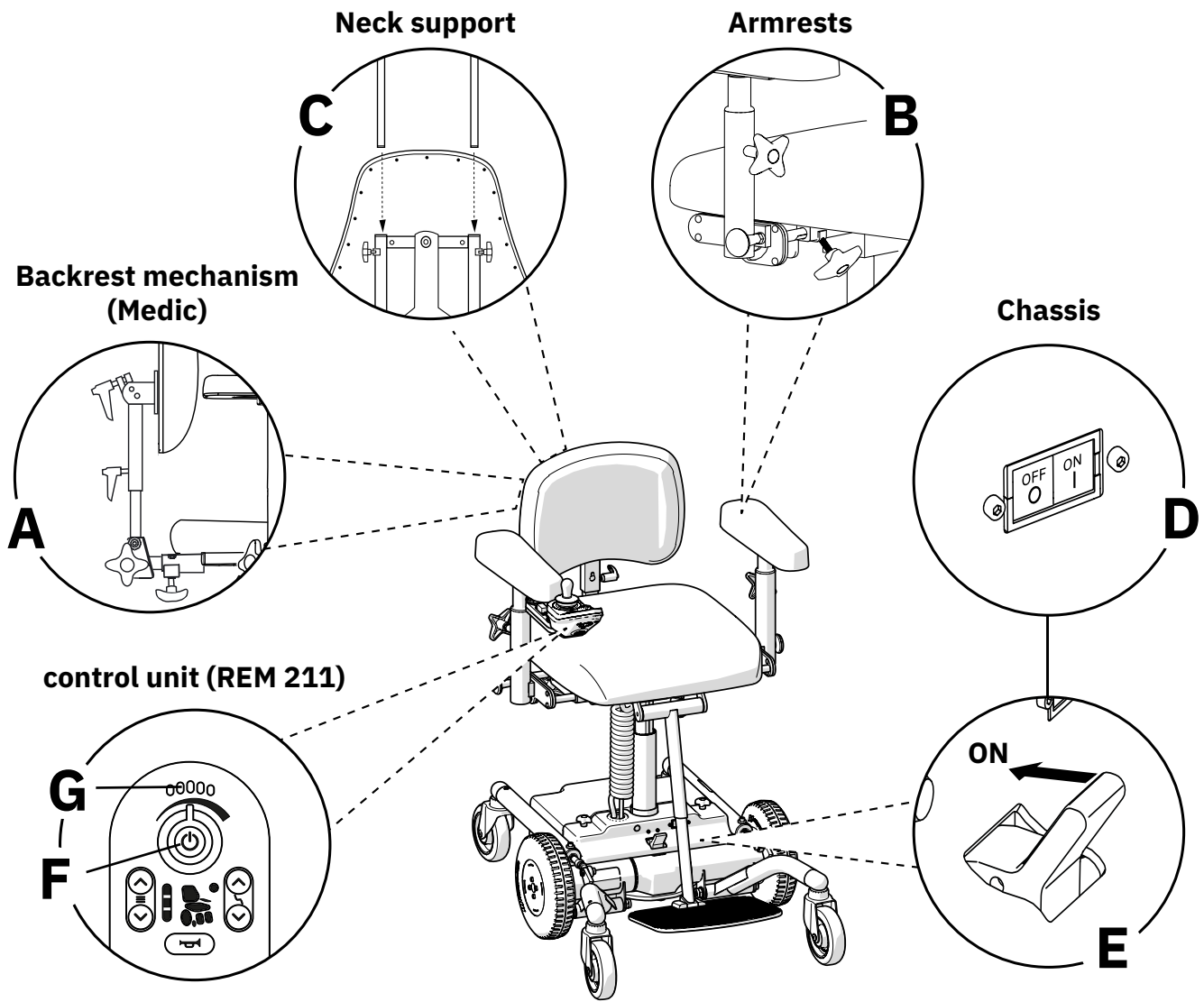

Figure 2.1. Preparations before the device is put into use.

**Consider the following before and during use of the device**

- All settings controls should be tightened before using the device.
- The device must not be used without fitting the backrest.
- The device must not be used without fitting the armrests.
- Do not use the device without leg supports.
- Your feet should always be in contact with the leg support footplate when using electrical functions.
- The leg support must not be adjusted so that it is in contact with the floor.
- The leg support is designed for you to rest your feet on, not to stand on.
- If the device is fitted with a belt, do not drive without fastening the belt.
- The seat must never be set to a height where you are unable to get out of the device safely.
- If the device is equipped with a seat tilt, the should be in the fixed position when you sit down or get up.

- Operate the device with caution when the seat is in the raised position. The power of the motors is automatically reduced when the seat height is too high to be driven with adequate stability at higher speeds, thereby also affecting the ability to avoid obstructions.
- The device must be operated with care. Always be aware of your surroundings before moving. Pets or children on the floor could be easily hit.
- Charge the device according to these instructions in this user manual, see 2.3. Charging.
- The charger must not, fully or partially, be immersed in water or covered with snow.
- Turn the device off when it is not in use.
- control unit emergency stop: If, for some reason, the device does not cancel a movement when the control unit lever is released, the movement can be stopped by pressing the main switch.
- Wireless emergency stop with remote control: An assistant can remotely stop the device using an emergency wireless stop (accessory). To activate the emergency stop, quickly press the remote control button once. To deactivate the emergency stop, quickly press the remote control button once.
- Button lock on the LiNX REM211 control unit: To activate the button lock, press and hold the main switch for at least 4 seconds. To deactivate, press and hold the main switch until the horn button flashes green. Press the horn twice within the space of 10 seconds.
- Button lock on the LiNX REM400 and LiNX REM500 control units: To activate the button lock, press and hold the main switch for at least 4 seconds. The button lock is activated when a padlock symbol is displayed. To deactivate the button lock, press and hold the main switch until the padlock symbol appears on the display. Press and keep holding the padlock symbol within the space of 10 seconds.
- Alarm for brake disengagement: If the brake is disengaged (OFF) when the device is ON position, the control unit will display an alarm and you will not be able to drive the product. When the brake is re-engaged, the alarm will disappear and the device can be driven again.
- Limp mode: In the event of less serious defects, you can continue driving the device in limp mode. Driving in limp mode means that the device can still be driven but at reduced speed. In the event of serious errors affecting driving safety, the device will automatically stop. The device can subsequently not be used until the fault is fixed. Try restating the device if an error is signalled.. If the error persists, contact your prescriber or distributor, see 1.1. Contact details.



Warning! As a user, you should contact your prescriber, technical aids centre or distributor if the device shows reduced or altered performance. A device showing a loss of or change in performance must immediately be taken out of use in order to avoid an accident. The device must not be used again until an authorised technician has examined the device.



Warning! To maintain safety, the device should only be used by the person and purpose for which it is intended. The device is set up for a single user. Changing settings may affect the user's seating position, which may result in damage or injury.





Warning! You are not permitted to modify the device yourself. If you would like individual customisation, contact your prescriber or distributor. If the device is modified, the CE marking no longer applies and Mercado Medic may no longer have full device liability. Modifications may affect the safety of the device and lead to accidents.



Warning! The device may be equipped with long cables or wires that cannot be secured in order for the device to function properly. Cables and wires can pose strangulation risks to small children, for example. Do not leave the device unattended with small children nearby.



Warning! The device is equipped with small components such as the cover plug on the front panel. Small parts that have come loose can pose choking hazards for children and pets.



Warning! Metal surfaces may become very hot if they are exposed to direct sunlight. Skin contact with hot surfaces can lead to burns. Avoid exposing metal surfaces to direct sunlight.



Warning! Always ensure that the device's brake is applied when sitting down and getting up. If the device is not braked, it risks rolling away when you get up or sit down, which can lead to fall injuries.

## 2.2. Driving and electric height adjustment

As standard, the device is equipped with a LiNX REM211 control unit. To drive the product, select the drive function using button (A) on the control unit, see Figure 2.2. During driving, the device is controlled by means of the control unit joystick. For electrical height adjustment, select the seat height adjustment function using button (B) on the control unit, see Figure 2.2. Use the control unit joystick to control electric height adjustment. The device can also be equipped with several electrical and manual seat functions. See section 5. Configurations and settings for detailed information about all the features and controls of the device.

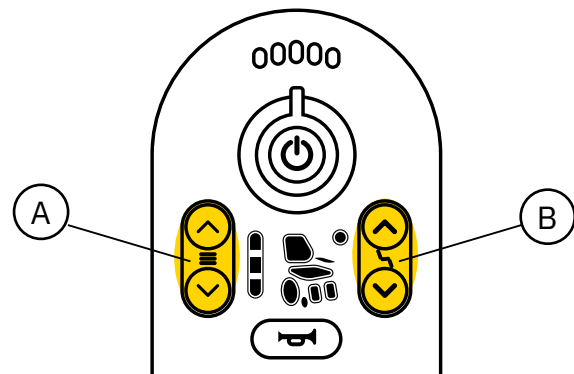

Figure 2.2. Choice of driving and seat functions on the LiNX REM211.

See Figure 2.3-2.5 to determine which control unit your device is equipped with. For detailed information on the use of respective control unit, see 5.3. Control unit.

### 2.3. Charging

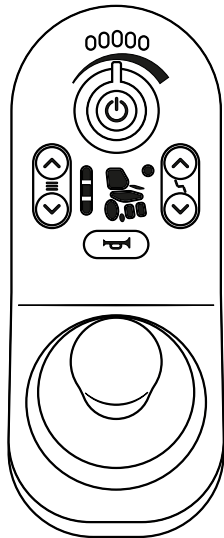

Figure 2.3. LiNX REM211 Control unit.

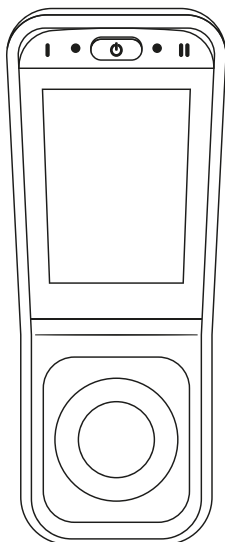

Figure 2.4. LiNX REM400 Control unit.

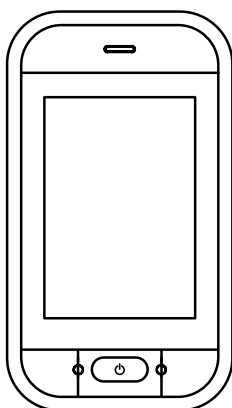

Figure 2.5. LiNX REM500 Display Box.

The device should be charged once a day. Charge the device in a well-ventilated area at room temperature. Before each charge, check to make sure that the charger's cables and connectors are not damaged or worn. The device must be charged in a safe manner. For this reason, choose an easily accessible wall socket to plug the charger into. In case of emergency, disconnect the device from the mains by unplugging the charger from the wall socket.

Fully charging the battery on a daily basis will take 6 to 16 hours. It is important that the battery is never completely discharged, as this helps to prolong the life of the battery. A fully discharged battery must be charged for at least 24 hours. The battery charge level is displayed on the control unit. Three levels of battery charge are indicated using the colours green for high level, yellow for moderate level and red for low level. Always charge the device before the battery level goes down to red, low level.



**Warning!** Only use chargers approved by Mercado Medic to charge the product. The use of other chargers may, for example, result in the risk of fire or interference with other electronic equipment. See 7. Technical information for approved chargers.



Chargers with damaged or worn cables and connectors must be immediately removed from service. Worn cables or connectors can lead to short circuits and the risk of fire. Contact your prescriber or distributor to replace the charger, see 1.1. Contact details.



Batteries emit explosive gases during charging. Consequently, charge your device in well-ventilated area and avoid flames and sparks. There will be a risk of fire if the gases ignite.

**How to charge the device**

1. Connect the charger plug into the wall socket. The ON/OFF symbol lights up green to indicate that the charger is connected to the mains.
2. Plug the charging contact into the charging socket. The charging socket is located on the front edge of the control unit and labelled with a battery symbol. The battery symbol on the charger will flash green to indicate that charging is in progress. PLEASE NOTE! The charger is equipped with protection against overheating but will become heated during charging.
3. The battery is fully charged when the battery symbol on the charger lights up with a steady green.

The charger consumes little power and cannot overcharge the battery. For this reason, the charger may be connected even if the battery is fully charged. Unplug the charger before using the device.

If no electrical functions are working, try charging the battery. If electrical functions still do not work, contact your prescriber or distributor, see 1.1. Contact details.

**2.4. Transferring and moving**

Only transfer to and from the device on a flat surface. Make sure that the device is switched off and the brake is applied to avoid unexpected movement during the transfer. Always consult with your prescriber about the most suitable technology to facilitate your transfer in and out of the device.

**Transfer from the side**

Use your arms to transfer from the side by shuffling sideways to or from the seat of the device. Position the device by driving it parallel to that piece of furniture you want to transfer to or from, see Figure 2.6.

When transferring to the device, the height of the seat should be a little lower than the height you are transferring from. Adjusting the seat height to the correct position. Lower the armrest to the side you moving over. Use the armrest on the other side as a support.

When transferring from the device in a seated position, the height of the seat should be a little higher than the height to which you are moving.

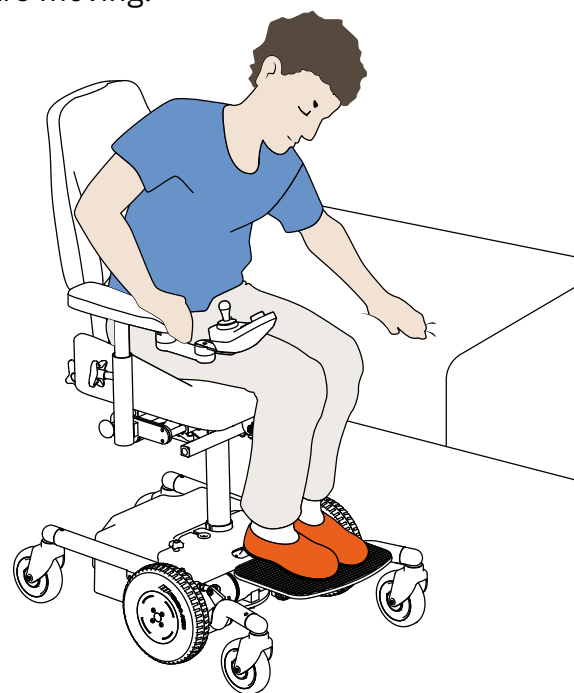

Figure 2.6. Transfer from the side.

### Transferring from the front

When transferring from the front, the movement will be forward to or from a piece of furniture to which or from which you wish to move, see Figure 2.7. Position the device directly opposite or at an angle in front of the piece of furniture to which you wish to move. Depending on your strength and ability to move, you should not make this move on your own without having previously trained at doing it in a safe manner. It may be beneficial to try out procedures for positioning the device and the other piece of furniture, i.e., positioning the legs of the other piece of furniture in a certain way in relation to the device and ensuring that they are similarly positioned on every occasion.

Before transferring to the device from the front, the footplate should be folded away or lowered to enable you to be as close to the seat as possible. The front edge of the seat should not be higher than the hollow of your knee. This makes it easier for you to get far into the seat immediately,.

When transferring from the product, the seat should be raised to a higher position than the furniture to which you are moving. This will save energy and allow to focus on a save movement with good support points.

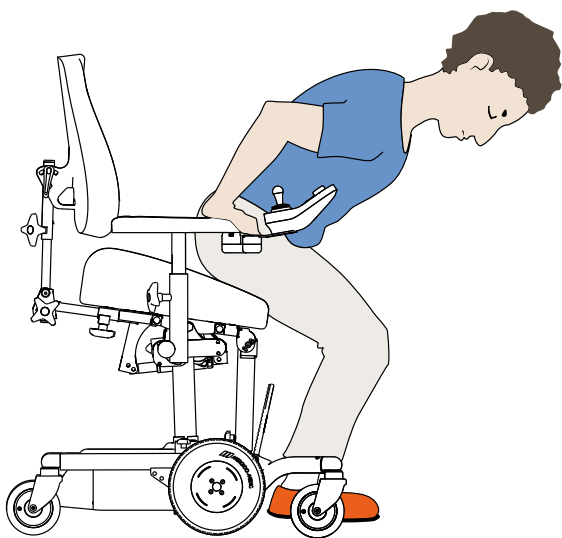

Figure 2.7. Transfer from the front.

If a patient lift is used during the transfer to and from the device are used when moving to and from the device, possible pinching risks should be taken into account. Make sure that your hands, feet and any clothing do not get in the way and risk being damaged.

### Avoiding obstacles

For the best possible conditions for negotiating thresholds and the like, the seat should be lowered to maximise stability and disable speed reduction. Driving profile 2 facilitates access over thresholds, as it performs well over obstacles and its speed is not excessive. For more information about changing the driving profile, see section 5.3. Control unit.

### Driving on a ramp

Before driving on a ramp, always check that the ramp can cope with the total weight of you and the device. Lower the seat height and straighten any seat tilt to increase stability. The device should always be driven straight up or down the ramp, see Figure 2.8. Always reverse the device when driving down a ramp. If the incline exceeds 3 degrees, always reverse the device when driving down the hill.

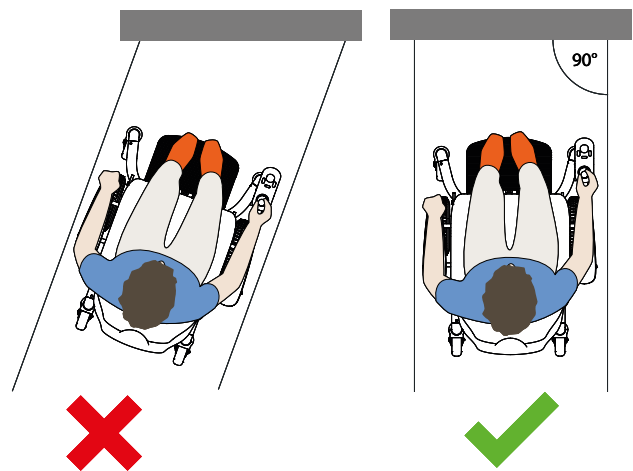

Figure 2.8. Driving on a ramp.

## 3. Caring for the device

Clean the device according to the instructions in this section to maintain its functions and service life. If you still have issues that cannot be resolved using available home resources, please contact your prescriber or distributor for reconditioning.

PLEASE NOTE! Do not wash the device with water or other liquids and chemicals.

### 3.1. Padded parts

To maintain good device hygiene, the device's padded parts should be cleaned regularly. If padded parts are not regularly cleaned, the device may require reconditioning.

#### Plush padded parts

Use a foam cleaner to clean plush padded parts. Start by removing any loose debris. Then use a cloth to distribute a thin layer of foam. Wipe with a clean, damp cloth. Finish by vacuuming the upholstery after it has dried.

#### Synthetic leather padded parts

Use soap and water or surface disinfectant to clean synthetic leather padded parts. Start by removing any loose debris. Then use a cloth to clean the upholstery with soap and water or surface disinfectant. If the upholstery is cleaned using soap and water, finish by wiping with a clean, damp cloth.

#### Leather padded parts

Use water to clean leather padded parts. Start by removing any loose debris. Then clean the upholstery with a clean, damp cloth. For best effect, padded parts should be cleaned immediately after something is spilled on it. To extend the service life of padded parts, avoid direct contact with chemicals or prolonged sunlight.

### 3.2. Castors and brake feet

Regular cleaning of castors and wheels is required to maintain the operation of the device. Wipe the wheel tracks with a lightly moistened cloth. Remove any hair from the castors using a thin crochet needle or similar implement.

### 3.3. Other parts

The device's lifting mechanism and other actuators, see Figure 3.1 (may be in electric seat tilt, back rest mechanism and leg supports), should not be cleaned. This is because there is a risk that the grease required for these mechanisms to function as intended might be removed during cleaning.

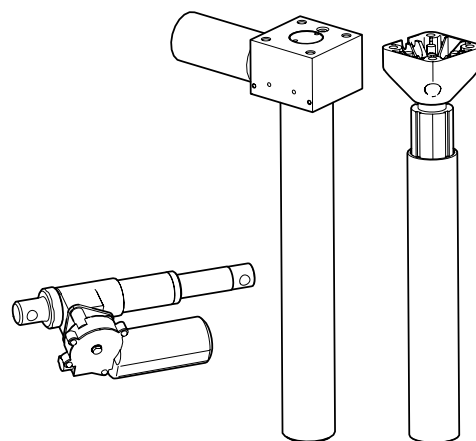

Figure 3.1. device's lifting mechanism and other actuators.

If necessary, a dry cloth can be used to remove dust from any electronic device components, including the charger. Clean the other non-electronic parts of the device once a week or when necessary. Use a clean, damp cloth with mild detergent (pH 7-12), surface disinfectant or use a steam cleaner (max. 8 bar).

### 3.4. Transport and storage

When transporting and storing the device, keep the following in mind:

- The device moves by rolling on a flat surface. The brake must be disengaged in order to roll the device. To disengage, pull the lever to the "OFF" position. To activate the brake, push the lever to the "ON" position, see Figure 3.2.

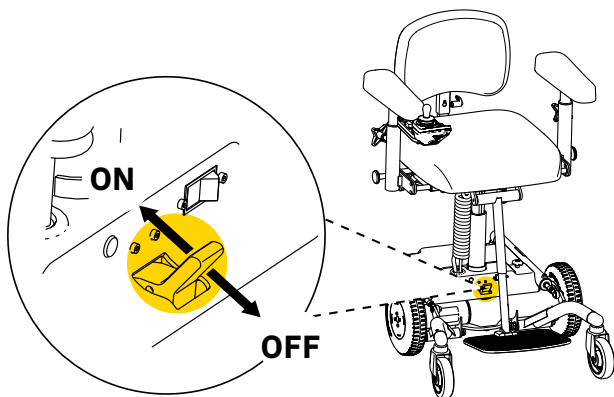

Figure 3.2. Disengaging the brake.

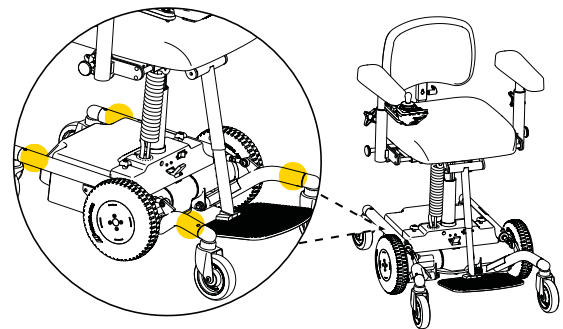
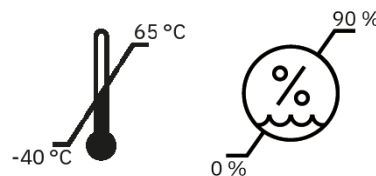

Figure 3.3. Suitable grips when lifting.

- The device should be lifted by two people. There are suitable grips on the front legs and the rear legs of the chassis, on the right and left sides, see Figure 3.3.

- The device is approved for transportation/storage at -40°C to +65°C and up to a 90% non-condensing relative humidity.



- For shorter storage periods where the battery is not disconnected, the battery must be charged at least once a month. The device can also be continuously trickle charged by keeping the charger connected for the entire storage period.

- In the event of a longer period of storage, the battery should be disconnected. This can be effected using the contact breaker, see Figure 3.4. Press "OFF" to disconnect the batteries. When the battery is disconnected, it must be charged every four months in order to retain its functionality. Prior to charging and when the device is to be put back into service, the circuit breaker must be reset; press "ON". After the circuit breaker has been disconnected, the control unit must be restarted twice to restore the device's functions. Fully charge the batteries before use, see 2.3. Charging.

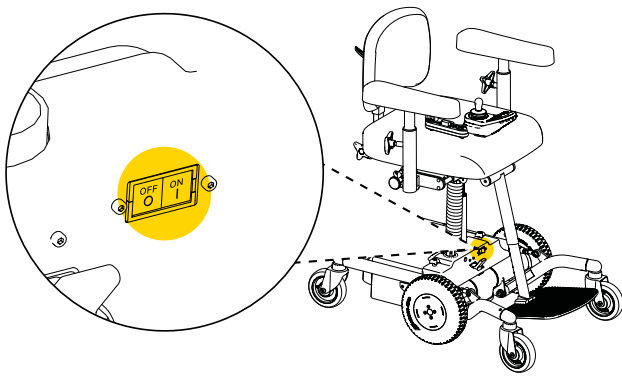

Figure 3.4. Contact breaker

- The device may not be used as a seat when transported in a vehicle or an aircraft etc.
  - The battery must be disconnected during transport. This can be effected using the contact breaker, see Figure 3.4. Press "OFF" to disconnect the batteries. Press "ON" to reset the circuit breaker. After the circuit breaker has been disconnected, the control unit must be restarted twice to restore the device's functions.
  - The device must be adjusted to the lowest possible seat height during transport. To reduce the size of the device during transport, the backrest can be removed and the armrests lowered. Be sure to mark the settings so that they can be easily reset. Tape or similar easily removable marking is recommended.
  - During transport with a transportation service, the device must be equipped with transport loops and must be secured using the transport vehicle's tension straps. The device must not be used as a seat during transport.
  - In the case of air transport, the device must be stored in the hold. Original Mercado Medic batteries are approved for air transport. For information on battery type, see 7. Technical information.
- Never place a fully discharged battery away for storage. Batteries that are discharged for too long, will be damaged and must be replaced.
  - The device is approved for all types of transport.
  - Where possible, the device must be transported on a pallet in a designated cardboard box. When transported without a pallet and a designated cardboard box, the device must be equipped with transport loops and anchored to the vehicle with straps. Transport loops (accessories) can be ordered using article number TR1010. For more information, please visit our website [www.mercado.se](http://www.mercado.se).



Warning! The device must never be transported in a vehicle with its brake disengaged. If the device's brake is not applied and it is left on a slope, it will start rolling with the risk of drop or crush damage/injuries as a result.

## 4. intended use

The REAL 6100 PLUS is an electric wheelchair for indoor use designed to be used by people with a reduced ability to walk, but with sufficient physical, cognitive and perceptive ability to safely drive an electric wheelchair. The device is normally designed to be driven by the user himself/herself, but can also be driven by an assistant if the device is equipped with attendant control.

The REAL 6100 is designed and recommended for one or more of the following indications:

- Inability to walk and severely limited ability to stand.
- Limited ability to stand up.
- Limited ability to maintain an adequate seating position.
- The use of a manual wheelchair is not possible due to disability, but safe use of an electric wheelchair is still possible.
- The use of a manual wheelchair is not suitable due to disability and the activities that need to be carried out on a daily basis.

### Contraindications

Known contraindications are cognitive and perceptive disabilities that make it unsuitable to independently drive an electric wheelchair, e.g., severe visual impairment. If the device has been purchased without a prescription from a qualified healthcare professional, the user should consult his/her doctor as to whether there are any contraindications.

### 4.1. Operating environment

- The device is intended for indoor use only and must not be used outdoors. The device has limited accessibility and stability when being driven outdoors, which may put the user at risk.
- The device is tested and approved for use between +25°C and +50°C and in 15 to 90 % non-condensing humidity. If the device is stored in an environment outside these limits, the device must reach room temperature before use.

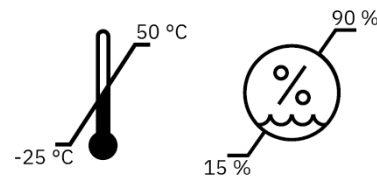

- The device must not be exposed to extreme cold or heat, prolonged sunlight or other radiation.
- The device must not be exposed to water, liquids or chemicals to any extent other than that specified in the care information in Section 3. Caring for the device.



## 5. Configurations and settings

This section is primarily aimed at you as a prescriber of the device. It describes the device's models, options when configuring the device, and information about setting and adjusting the device's functions. For dimensions and performance, see 7. Technical information.

The device is available in several configurable models. The basic design of each model is described below, see 5.2. Basic design. In addition to the basic design, there are a large number of options to personalise the device. For available options, see the description for each function in this section. The models can also be equipped as positioning chairs with such things as torso support, side support and a head rest, and further customised both within and outside the CE marking, see 5.14. Individual adaptation. For information about accessories and current combination agreements please visit our website [www.mercado.se](http://www.mercado.se). For an overview of accessories, read the document 'Accessories'.

The device is compatible with two seating systems, ErgoMedic and ErgoMedic Plus. The seating systems include seats, backrests and armrests. The padded parts can be combined as needed for support, relief and stability when sitting. For users with pain problems, the Slow Recovery variant is available for both seating systems. This variant contains a pressure-relieving foam that is activated by body heat. If there are special needs, a seat with anti-slip material can be installed for use of third-party seat cushions, see 5.14. Individual adaptation. For more information about the seating systems and other padded parts, please visit our website [www.mercado.se](http://www.mercado.se). For an overview of available upholstered details, read the document 'Seat systems'.

On [www.mercado.se](http://www.mercado.se) there are various forms of prescription support such as information sheets, order forms and a digital chair configurator. There are also instructions for use and device information for all Mercado Medic devices.

### 5.1. Required level of competence for setting and adjusting

The functions and accessories for positioning and relief sitting should only be set by the prescriber of the device unless otherwise agreed, as this requires knowledge of good sitting positions. These features and accessories include neck support, trunk support, side support, Coxit mechanism, leg support and width adjustment of armrests.

Users themselves can set daily functions such as the adjustment of seat height, seat tilt, gas spring-operated back rest mechanism where this is appropriate and if this can be done safely.

The driving characteristics of the device should be customised to the user so that the device can be driven safely. For more information about the device's basic program and customisation options, see 5.2. Basic design and 7.1. Programming the device.

## 5.2. Basic design

The device is always delivered with a seat, back rest, armrests, leg supports, a control unit (LiNX REM211 as standard) an angular seat frame that does not allow seat tilt, as well as a chassis with four castors (125 mm) and two drive wheels (225 mm). The device has electrical height adjustment that is controlled via the control unit.

PLEASE NOTE! The basic design of the device may vary between regions and contracting entities.

### REAL 6100 PLUS LiNX

Adult model

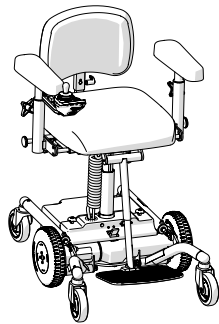

### REAL 6100 PLUS LiNX Child

Child model

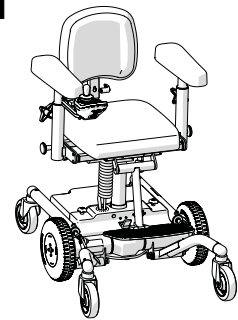

The device has a basic program with three pre-programmed driving profiles. All parameters in the driving profiles are adapted to the different speeds.

- Program 1/Slow: A slow program for manoeuvring in small spaces and fine-tuning. Maximum speed 1.5 km/h.
- Program 2/Medium: A medium-speed program for manoeuvring between rooms in a flat etc. Maximum speed 3 km/h.
- Program 3/Fast: A fast program for manoeuvring in large spaces and long corridors. Maximum speed 4 km/h.

The basic program includes drivers for all control units and electrical seat functions. Thus, optional accessories can be fitted without the need for reprogramming. Driving profiles can also be reprogrammed to customise driving characteristics. For more information, see 7.1. Programming the device.

## 5.3. Control unit

The control unit is used for driving and the adjustment of seat functions. The control unit is available in two models, LiNX REM211 (standard) and LiNX REM400 (optional). The device can also be equipped with display box LiNX REM500 (optional), Attendant Control LiNX DLX-ACU200 (accessory), Keypad LiNX (accessory) and a wireless emergency stop (accessory). The LiNX REM500 Display Box is used in combination with third-party control systems. Attendant control is an additional control unit with a secondary joystick that can be located on the back rest and allows an attendant to operate the device if necessary. The LiNX keypad is a complement to the control unit providing direct access to the adjustment of seat functions. A wireless emergency stop allows an attendant to stop the device from a distance.

Control unites can be mounted using two types of attachment, a control arm and ParaLoc (optional). The control arm is articulated at two points and allows movement of the control unit towards the inside and outside of the armrest. The joints can either be locked in a fixed position or be mobile with an adjustable resistance. With ParaLoc, the control unit retains its forward direction when the control arm is rotated outwards or inwards. ParaLoc has a lock mode; this is normally placed straight ahead of the armrest. You can also adjust the lock mode by adjusting the magnetic arm, see Figure 5.2. The depth of both types of attachment can be adjusted and the attachment can be mounted on the right or left side.

### Control arm

The control arm is adjustable in depth (A) and has adjustable resistance in joints (B), see Figure 5.1.

Depth setting:

1. Remove the screw using a 5 mm Allen key and a 10 mm ring spanner.
2. Move the control arm to the desired position (three possible positions) and then refit the screw.

Setting the adjustable resistance in joints:

1. The resistance in each joint can be regulated steplessly by tightening or releasing the Allen screw on the underside of the control arm at each end.

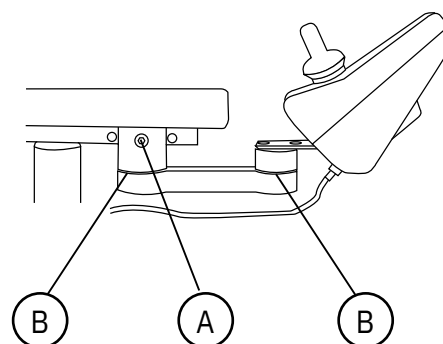

Figure 5.1. Control arm.

### ParaLoc

ParaLoc is adjustable in depth (A) and is able to adjust the position of the magnetic arm's lock mode (B), see Figure 5.2.

For depth adjustment, see Control arm.

Setting the lock mode of the magnetic arm:

1. Place the magnetic arm against the magnet so it is fixed. Loosen the screws and adjust the control arm to the desired position.
2. Tighten the screws.

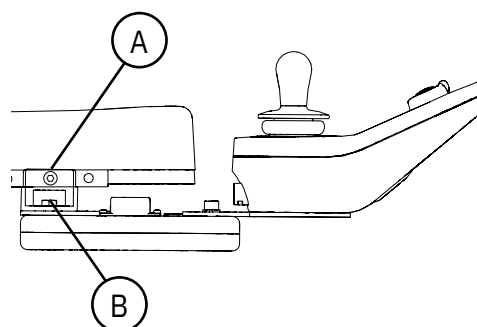

Figure 5.2. ParaLoc.

Check the control unit when starting the device. A flashing red light on the main switch will signal there is an error. The number of flashes indicates the fault that has occurred; see 8.1 for more information. Troubleshooting guide.

In the event of less serious defects, you can continue driving the device in limp mode. Driving in limp mode means that the device can still be driven but at reduced speed. In the event of serious errors affecting driving safety, the device will automatically stop. The device can subsequently not be used until the fault is fixed.

### Inspecting the control unit

1. Turn on the circuit breaker, see Figure 5.3.
2. Turn on the main switch (F), see Figure 5.4.
3. Check that the battery level indicator is at least showing a yellow marking, see Figure 5.5. Charge the device if the indicator is showing a red marking. See 2.3. Charging.
4. Make sure the light on the main switch is green.

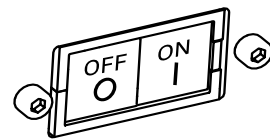

Figure 5.3. Contact breaker.



Figure 5.4. Main switch.



Figure 5.5. Battery level indicator.

## Control unit LiNX REM211

The LiNX REM211 is a control unit with a joystick, buttons for selecting driving and seat functions, a battery indicator and a horn. It is also equipped with controls to temporarily adjust the driving characteristics within the selected driving profile.

### Driving features

Controls for driving functions are illustrated in Figure 5.6.

Driving profile selection:

- Press the buttons (A); see Figure 5.6 for driving profile selection. The selected driving profile is indicated on the display with one, two or three lit LEDs.

Driving and speed adjustment:

- Make sure that the green tyre symbol (B) lights up on the display. This indicates that a driving function has been selected.
- Drive the device by moving the joystick in the direction in which the device is to be moved. Straight forward for forward driving, obliquely to the right or left to turn and straight back reversing. Small joystick movements will cause the device to move slowly, while larger movements will cause the device to move faster.
- The device can also be rotated by moving the joystick directly to the right or left.
- To adjust the driving characteristics within the selected driving profile, use the steering wheel (C) that is located around the main switch. The lever adjusts the speed range defined in the driving profile.

Brake:

- To brake, release the joystick so that it returns to its neutral position. For faster braking, move the joystick in the opposite direction to the direction of travel. PLEASE NOTE! The braking distance is affected by the slope of the surface. Downhill braking requires a longer braking distance while uphill braking requires a shorter braking distance.

Horn:

- Press the horn (D) button for an audible signal.

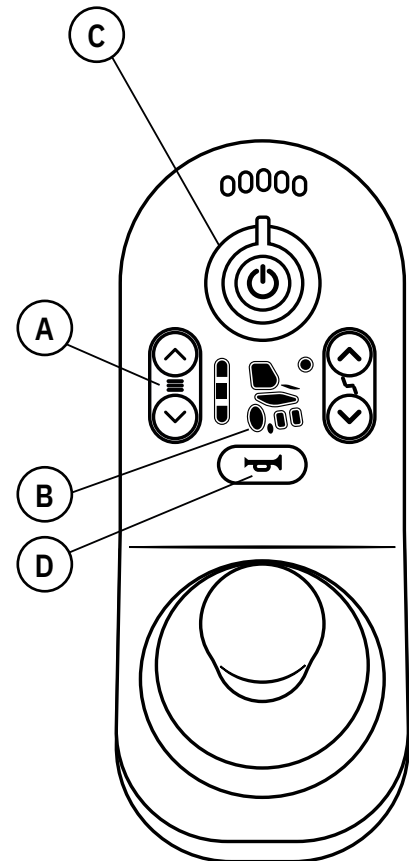

Figure 5.6. Controls for driving functions on the LiNX REM211.

**Seat functions**

Press the buttons (E) to select the seat function, see Figure 5.7. An orange light on the display indicates the selected seat function. You can also switch between seat functions by moving the joystick sideways.

See 5.4 for adjustment of seating functions. Electric seat functions.

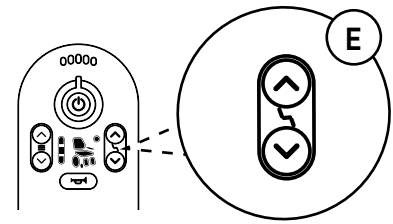

Figure 5.7. Controls for seat functions on the LiNX REM211.

**Emergency stop**

When driving or adjusting seat functions, you can quickly cancel movement by releasing the joystick or by pressing the main switch (F), see Figure 5.8. The control unit switches off and the electrical function stops.

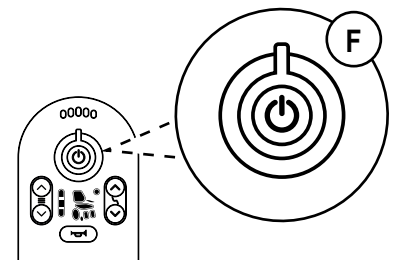

Figure 5.8. Emergency stop on the LiNX REM211.

**Button lock**

Activating and deactivating the button lock:

1. To activate the button lock, press and hold the main switch for at least 4 seconds until the green, yellow and red LED flashes three times. The control unit will switch off.
2. To disable the button lock, press the main switch and wait until the green, yellow and red LED flashes. Then, press the horn button twice in the space of 10 seconds, see Figure 5.9. The control unit is activated.

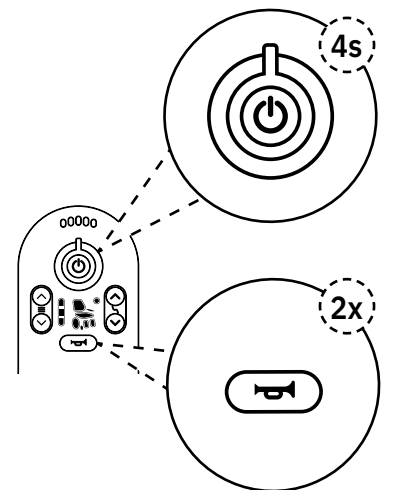

Figure 5.9. Button lock on the LiNX REM211.

**Automatic shutdown**

By default, the system’s automatic shutdown feature is enabled. This means that the device automatically shuts down the electrical functions after 5 minutes of inactivity to save battery power. The time interval for automatic shutdown is adjustable between 1 and 5 minutes. Press any button to restart the electronics.

**Control unit LiNX REM400**

The LiNX REM400 is a control unit with a joystick, buttons for selection of driving profile and seat function, a battery indicator and a horn.

When the electronics start up, the function that was active when the electronics were switched off is always opened. It is important that the joystick is not affected when the electronics start up. If this is the case, no driving function or seat function will work until the joystick returns to the unaffected position.

If the control unit is not in use for 30 seconds, the display is restored to the base menu with driving profiles in the upper row (green) and seat functions in the lower row (orange).

**Driving features**

Controls for driving functions are illustrated in Figure 5.10.

Driving profile selection:

- Press button I (A) to switch between the driving function mode and seat mode. Select the driving function. Press button II (B) to select the driving profile. You can also switch between the driving function mode and the seat function mode on the display using the navigation button (C) by dragging your finger sideways across the screen (sweep).

Driving and speed adjustment:

- Make sure that the driving function is selected, see Figure 5.10.
- Drive the device by moving the joystick in the direction in which the device is to be moved. Straight forward for forward driving, obliquely to the right or left to turn and straight back reversing. Small joystick movements will cause the device to move slowly, while larger movements will cause the device to move faster.
- The device can also be rotated by moving the joystick directly to the right or left.
- To adjust the driving characteristics within the selected driving profile, move your finger up or down on the speed control on the display (D). The lever adjusts the speed range defined in the driving profile.

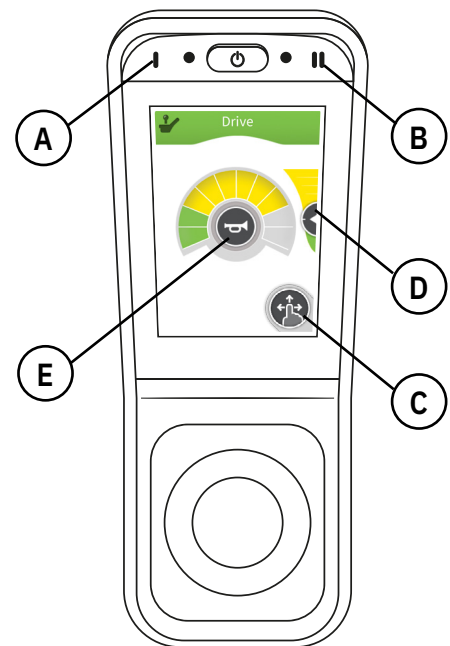

Figure 5.10. LiNX REM400 driving functions.

**Brake:**

- To brake, release the joystick so that it returns to its neutral position. For faster braking, move the joystick in the opposite direction to the direction of travel.  
PLEASE NOTE! The braking distance is affected by the slope of the surface. Downhill braking requires a longer braking distance while uphill braking requires a shorter braking distance.

**Horn:**

- Press the horn (E) for an audible signal; see Figure 5.10.

**Seat functions**

Press button I (A) to switch between the driving functions and seat functions, see Figure 5.11.. To select the seat function, press button II (B) until the desired selection is visible on the display. You can also switch between seat functions by moving the joystick sideways.

See 5.4 for adjustment of seating functions. Electric seat functions.

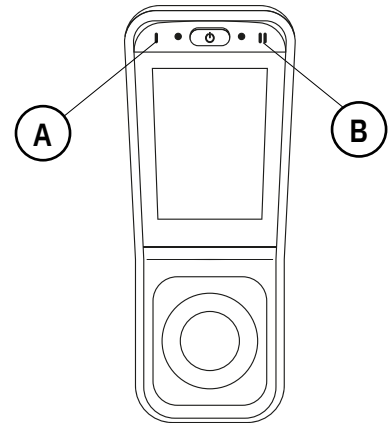

Figure 5.11. Controls for seat functions on the LiNX REM400.

**Emergency stop**

When driving or adjusting seat functions, you can quickly cancel movement by releasing the joystick or by pressing the main switch (G), see Figure 5.12. The control unit switches off and the electrical function stops.

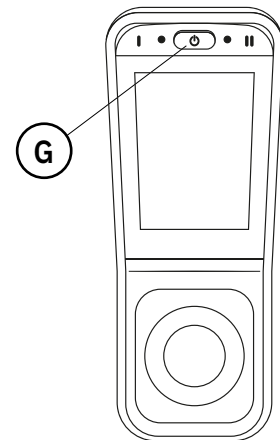

Figure 5.12. Emergency stop on LiNX REM400.



### Button lock

Activating and deactivating the button lock:

1. To activate the button lock, press and hold the main switch for at least 4 seconds until the display shows a padlock. All driving functions and seat functions are locked.
2. To disable the button lock, press the main switch and wait until the padlock symbol is visible, see Figure 5.13. Press and hold the padlock symbol within the space of 10 seconds until the driving function or seating function is visible.

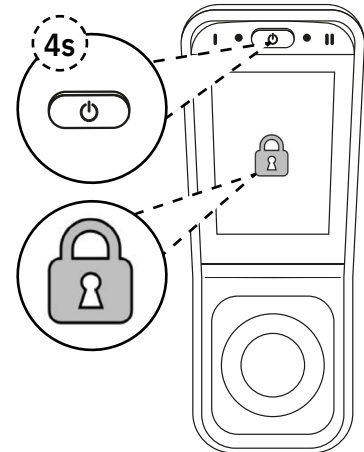

Figure 5.13. Button lock on LiNX REM400.

### Automatic shutdown

By default, the system's automatic shutdown feature is enabled. This means that the device automatically shuts down the electrical functions after 5 minutes of inactivity to save battery power. The time interval for automatic shutdown is adjustable between 1 and 5 minutes. Press any button to restart the electronics.

### LiNX REM500 Display Box

The LiNX REM500 is a display box with touch display, function buttons for selecting the driving function and seat function, a battery indicator and a horn, see Figure 5.14. The REM 500 does not have a joystick but is made for external joysticks and third-party control systems such as a mini-joystick, main control, etc. For more information, see 5.14 Individual customisation.

### Functions

For driving and seating functions, see LiNX REM400 control unit.

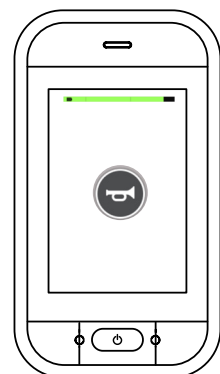

Figure 5.14. Control unit REM500.

### LiNX DLX-ACU200 Attendant Control

Attendant control is an additional control unit with a secondary joystick that can be located on the back rest and allows an attendant to operate the device as needed, see Figure 5.15.. Both driving functions and seating functions can be controlled with Attendant Control. By default, both the regular control unit and the attendant control can operate the device, but the system can also be programmed so that one of the control unites allows the other to operate.

#### Features

Both driving functions and seating functions can be controlled with Attendant Control.

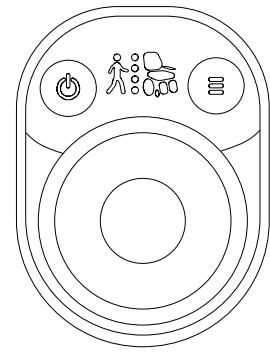

Figure 5.15. LiNX DLX-ACU200 Attendant Control.

### LiNX keypad

The LiNX keypad can be used to adjust the electric back rest mechanism (A), electric height adjustment (B) a centre-mounted electric leg support (C), a length compensatory leg support (D) and electric seat tilt (E), see Figure 5.16. The LiNX keypad is located between the control unit and the armrest.

#### Features

See 5.4 for adjustment of seating functions.  
Electric seat functions.

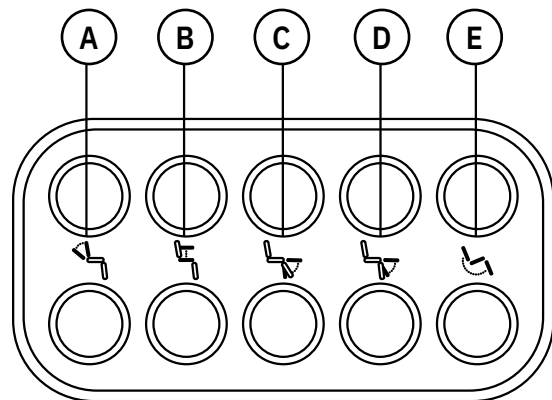

Figure 5.16. LiNX keypad.

## Wireless emergency stop

The device can also be equipped with a wireless emergency stop. A wireless emergency stop is plugged into the charging socket on the control unit and allows an attendant to stop the device from a distance.

### Features

Activating and disabling the wireless emergency stop:

1. To activate the emergency stop, quickly press the remote control button once.  
The chair brakes and stops, the joystick is deactivated and the chair cannot be driven.
2. To deactivate the emergency stop, quickly press the remote control button once.  
The chair can be driven once again when the joystick has returned to unaffected position.

## 5.4. Electric seat functions

The device can be equipped with up to four electric seat functions. These consist of electric height adjustment, an optional electric seat tilt, an optional electric back rest mechanism and an optional electric leg support. The back rest mechanism can be adjusted between 23° forwards to 28° backwards. An electric leg support is available in three versions, Mobil 6100, Comfort and Length Compensatory. Mobil 6100 is a centre-mounted electric leg support with a full footplate with a rim. The Comfort electric leg support has a split footplate and allows the angle of the right and left leg supports to be adjusted both individually and in parallel. The length-compensatory electric leg support has a split footplate and allows the length and angle to be adjusted simultaneously to always maintain support under the feet and thighs. Length-compensatory leg supports also allow the length to be adjusted separately.

PLEASE NOTE! Keep in mind that each added seat function shortens the distance driven by the device depending on how often it is used.

Electric seat functions can be adjusted in two ways, via a control unit or a keypad. For more information about other control unit functions, see 5.3. Control unit.

### Control unit

Adjust the seat function by moving the joystick forwards or backwards. With a small movement, the seat function is slow and with larger movements, the seat function is faster.

**Electric height adjustment**

1. Make sure that the seat symbol light on the display is orange, see Figure 5.17.
2. Move the joystick forward to raise the seat.
3. Push the joystick backwards to lower the seat.



Figure 5.17. Symbols for electric height adjustment.

**Electric seat tilt**

1. Make sure that the symbol light for both seat and back rest on the display is orange, see Figure 5.18.
2. Move the joystick forwards to angle the seat forwards.
3. Push the joystick backwards to angle the seat backwards.



Figure 5.18. Symbols of electric seat tilt.

**Electric back recliner**

1. Make sure that the back rest symbol light on the display is orange, see Figure 5.19.
2. Move the joystick forwards to tilt the tilt the back rest mechanism forwards.
3. Move the joystick backwards to tilt the back rest mechanism backwards.



Figure 5.19. Symbols of electric back rest mechanism.

**Mobile 6100 electric leg support**

1. Make sure that the back rest symbol light on the display is orange, see Figure 5.20.
2. Move the joystick forward to angle the leg support forwards and upwards.
3. Push the joystick backwards to angle the leg support downwards and backwards.



Figure 5.20. Symbol for electric leg support.

### El-Comfort electric leg support

To adjust the angle of both leg supports at the same time, select the right and left leg supports. To adjust only the angle of the right and left leg supports separately, select the right or left leg support, see Figure 5.21.

1. Make sure that the symbol light for right, left, or both right and left leg supports on the display is orange.
2. Move the joystick forward to angle the leg support forwards and upwards.
3. Push the joystick backwards to angle the leg support downwards and backwards.

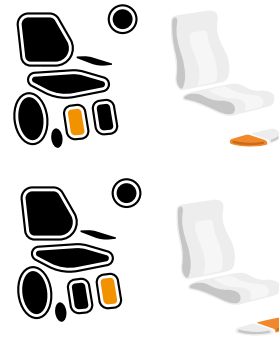

Figure 5.21. Symbols for split electrical leg support.

### Electric leg support leg support El R+L Length compensating

To adjust the leg support in a length-compensating motion, select both the right and left leg support.

1. Make sure that the symbol light for both right and left leg supports on the display is orange.
2. Move the joystick forwards to angle the leg support forwards and upwards in a length-compensating motion.
3. Move the joystick backwards to angle the leg support downwards and backwards in a length-compensating motion.

To adjust the length only, select the left leg support, see Figure 5.22.

1. Make sure that the left leg support symbol light on the display is orange.
2. Move the joystick forwards to raise the leg support.
3. Push the joystick backwards to shorten the leg support.



Figure 5.22. Symbol for adjusting the length of length compensatory leg supports.

## Keypad

The LiNX Keypad can be used to adjust the electric seat tilt, the electric back rest mechanism, electric leg supports and electric height adjustment.

### Seat height

Buttons above and below the seat height symbol, see Figure 5.23.

Adjustment:

1. Press the upper ascent button.
2. Press the lower descent button.

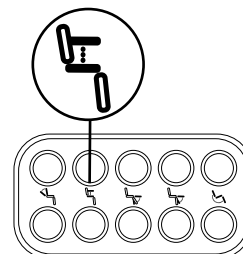

Figure 5.23. Buttons for adjusting seat height.

### Seat tilt

Buttons above and below the seat tilt symbol, see Figure 5.24.

Adjustment:

1. Press the upper button to tilt the seat forwards.
2. Press the lower button to tilt the seat backwards.

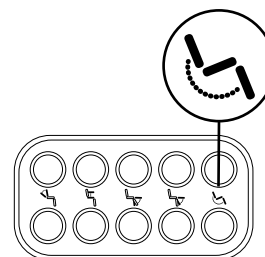

Figure 5.24. Buttons for adjusting seat tilt.

### Back recliner

Buttons above and below the back rest mechanism symbol, see Figure 5.25.

Adjustment:

1. Press the upper button to angle the back rest mechanism forwards.
2. Press the lower button to angle the back rest mechanism backwards.

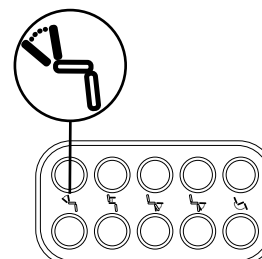

Figure 5.25. Button for adjusting back rest mechanism

### Leg support

Buttons above and below the symbol for adjusting the length of leg supports (A) and above and below the symbol for adjusting the length and angle of leg supports (B), see Figure 5.26.

Length adjustment:

1. Press the upper button to extend the leg support.
2. Press the lower button to shorten the leg support.

Adjustment of length and angle:

1. Press the upper button to angle the leg support forwards and upwards.
2. Press the lower button to angle the leg support backwards and downwards.

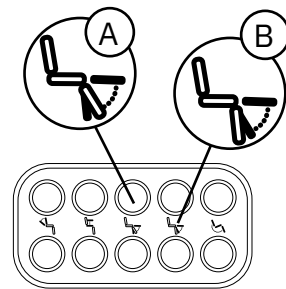

Figure 5.26. Buttons for adjusting leg supports.

### 5.5. Seat

Seats are available in three versions, ErgoMedic, ErgoMedic Plus and ErgoMedic Plus Coxit. These are also available with the optional Slow Recovery padding.

Seat upholstery is available in four materials: plush, synthetic leather (optional), patterned fabric (optional) and hygiene fabric (optional). Upholstery in hygiene fabric is used to protect the seat from moisture. Plush and hygiene fabric covers (optional) are also available for all seat designs and sizes. Hygienic fabric covers have a plush exterior and a plasticised interior. For more information about upholstery, covers and available colours, please visit our website [www.mercado.se](http://www.mercado.se). For an overview of available upholstery and covers, read the document 'Seat systems'.

#### ErgoMedic

ErgoMedic is a flat seat with seat indentation and extra support under the thighs, see Figure 5.27. The seat is available in sizes from 290 x 320 mm to 480 x 530 mm.

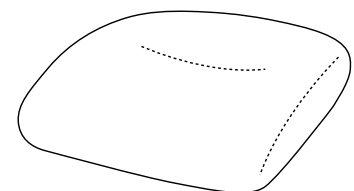

Figure 5.27. ErgoMedic seat.

#### ErgoMedic Plus

ErgoMedic Plus is a more positioning seat with raised sides for better relief, see Figure 5.28. The seat is available in sizes from 290 x 320 mm to 480 x 530 mm.

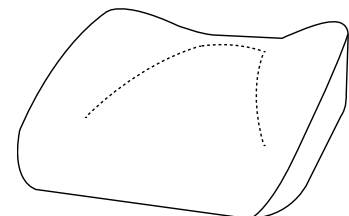

Figure 5.28. ErgoMedic seat.

**ErgoMedic Coxit**

ErgoMedic Coxit is a coxite seat with angularly adjustable flaps, see Figure 5.29. The seat is available in sizes from 400 x 390 mm to 440 x 480 mm.

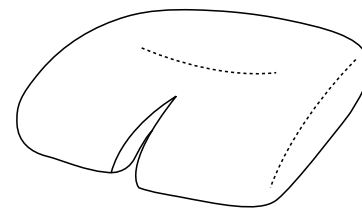

Figure 5.29. ErgoMedic Coxit seat.

**ErgoMedic Plus Coxit**

ErgoMedic Plus Coxit is a more positioning coxite seat with angularly adjustable flaps and raised sides for better relief, see Figure 5.30. The seat is available in sizes from 400 x 390 mm to 440 x 480 mm.

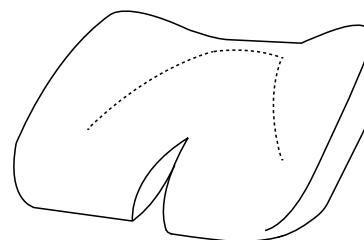

Figure 5.30. ErgoMedic Plus Coxit seat.

**5.6. Manual seat tilt**

There are three ranges of manual seat tilt (optional): standard (15° forwards, 8° backwards), reverse seat tilt (8° forwards, 15° backwards) and all seat tilt backwards (0° forward, 23° backwards). When selecting the option of all seat tilt backwards (0° forward, 23° backwards), the device must be equipped with rear leg extenders, see 5.13. Chassis. The device can also be configured prepared for seat tilt with a fixed brace that fixes the seat tilt in a flat position (0°). Manual seat tilt can be adjusted with the crank handle or gas spring lever. Adjustment of seat tilt is also available as an electrical function, see 5.4. Electric seat functions.

**Gas spring lever**

The lever for the gas spring can be located on the left rear edge of the seat or under the left armrest, see Figure 5.31.

Adjustment:

1. Lift and hold the lever to disengage the gas spring, adjust the seat tilt by moving your upper body weight forwards and backwards until the desired position is reached.
2. Release the lever to lock the seat tilt.

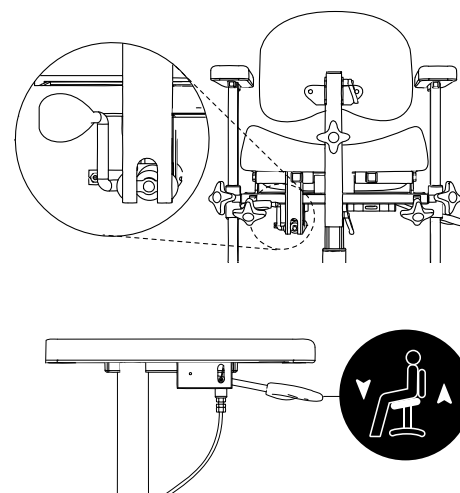

Figure 5.31. Gas spring lever for adjusting seat tilt.



**Crank handle**

The crank handle is located under the rear edge of the seat, see Figure 5.32.

Adjustment:

1. Turn the control to the right to move the seat tilt forwards.
2. Turn it to the left to move the seat tilt backwards.

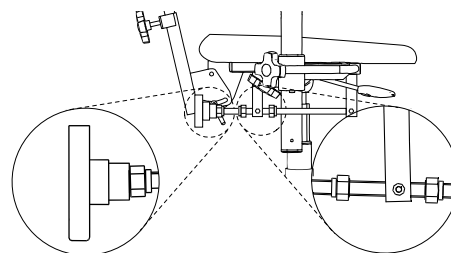

Figure 5.32. Crank handle for adjusting seat tilt.

**5.7. Coxit mechanism**

The Coxit mechanism has angle-adjustable flaps that can be angled down to a maximum of 45°. The flaps are set using a knob.

On configurations without the seat tilt, the control for the Coxit mechanism is located under the front edge of the seat on the right and left sides, see Figure 5.33. On configurations with a seat tilt, the Coxit mechanism control is located under the rear edge of the seat on the right and left sides, see Figure 5.34.

**Coxit mechanism with controls under the front edge of the seat**

Adjustment:

1. Loosen the knob, set the desired angle on the flap.
2. Tighten the wheel.

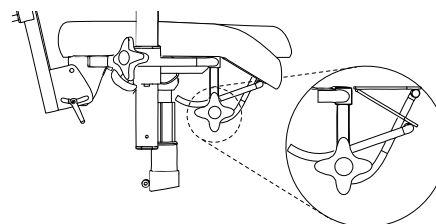

Figure 5.33. Control under the front edge of the seat for setting the Coxit mechanism.

**Coxit mechanism with control under the rear edge of the seat**

Adjustment:

1. Rotate the knob clockwise to lower the flap.
2. Rotate the knob anticlockwise to raise the flap.

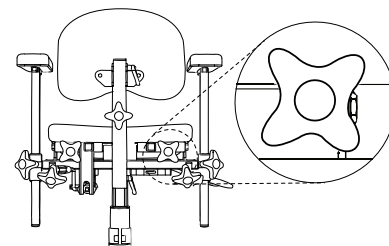

Figure 5.34. Control under the rear edge of the seat for setting the Coxit mechanism.

## 5.8. Backrest

Backrests are available in six versions: ErgoMedic, ErgoMedic Support (optional), ErgoMedic Plus (optional), ErgoMedic Plus with side wedge (optional), ErgoMedic Plus Comfort (optional) and ErgoMedic Plus Comfort with side wedge (optional). ErgoMedic and ErgoMedic Plus are also available in the optional Slow Recovery material. ErgoMedic Plus with side wedge is also available with reinforced side wedges (optional).

Backrest upholstery is available in four materials: plush, synthetic leather (optional), patterned fabric (optional) and hygiene fabric (optional). Plush and hygienic fabric covers (optional) are also available for all back designs and sizes. Hygienic fabric covers have a plush exterior and a plasticised interior. For more information about upholstery, covers and available colours, please visit our website [www.mercado.se](http://www.mercado.se). For an overview of available upholstery and covers, read the document 'Seat systems'.

### ErgoMedic

ErgoMedic is a lightly cupped back rest, see Figure 5.35. The seat is available in sizes from 270 x 220 mm to 460 x 430 mm.

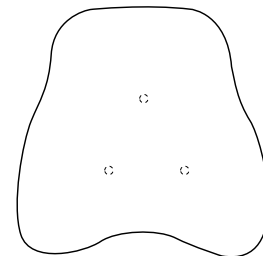

Figure 5.35. ErgoMedic backrest.

### ErgoMedic Support

ErgoMedic Support is a lightly curved back rest with more padding and an extra built-up lumbar support, see Figure 5.36. The seat is available in sizes from 350 x 430 mm to 460 x 430 mm.

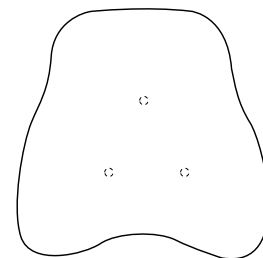

Figure 5.36. ErgoMedic Support backrest.

### ErgoMedic Plus

ErgoMedic Plus is a more positioning back rest with built-up sides for better support, see Figure 5.37. The seat is available in sizes from 230 x 200 mm to 460 x 430 mm.

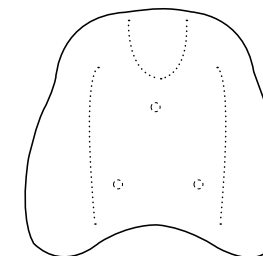

Figure 5.37. ErgoMedic Plus backrest.

**ErgoMedic Plus with side wedges**

ErgoMedic Plus with side wedges is a highly positioning back rest with extra built-up sides for better lateral stability, see Figure 5.38. The seat is available in sizes from 300 x 340 mm to 460 x 430 mm.

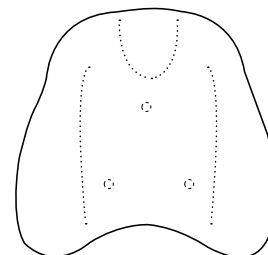

Figure 5.38. ErgoMedic Plus backrest with side wedges.

**ErgoMedic Plus Comfort**

ErgoMedic Plus Comfort is a more positioning back rest with built-up sides for better support, see Figure 5.39. The backrest also has adjustable lumbar support that provides extra support in the lumbar spine. The lumbar support is adjusted with a pump. The seat is available in sizes from 350 x 430 mm to 460 x 430 mm.

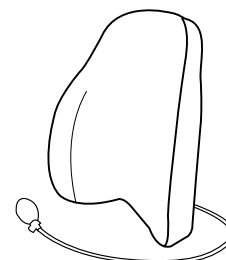

Figure 5.39. ErgoMedic Plus Comfort backrest.

**ErgoMedic Plus Comfort with side wedges**

ErgoMedic Plus Comfort with side wedges is a highly positioning back rest with extra built-up sides for better lateral stability, see Figure 5.40. The backrest also has adjustable lumbar support that provides extra support in the lumbar spine. The lumbar support is adjusted with a pump. The seat is available in sizes from 350 x 430 mm to 460 x 430 mm.

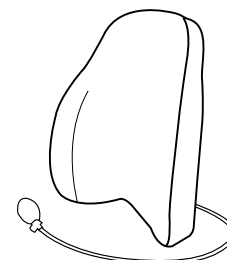

Figure 5.40. ErgoMedic Plus Comfort backrest with side wedges.

## 5.9. Manual backrest mechanism

The manual back mechanism is available in three versions, Standard, Medic (optional) and Comfort (optional). These are available in low and high models. Back rest mechanism adjustment is also available as an electrical function, see 5.4. Electric seat functions.

PLEASE NOTE! The illustrated back mechanisms are in the low model.

### Standard

Standard can be adjusted in height (A), angle of back rest (B) and angle of back rest mechanism (C), see Figure 5.41. The back recliner can be adjusted in the range of 15° forward to 30° backwards.

Height setting:

1. Loosen the knob and select the desired height for the back.
2. Tighten the knob.

Setting the angle of the backrest:

1. Loosen the handle and adjust to the desired angle.
2. Tighten the handle.

Setting the angle of the back recliner:

1. Loosen the knob and adjust to the desired angle.
2. Tighten the knob securely.

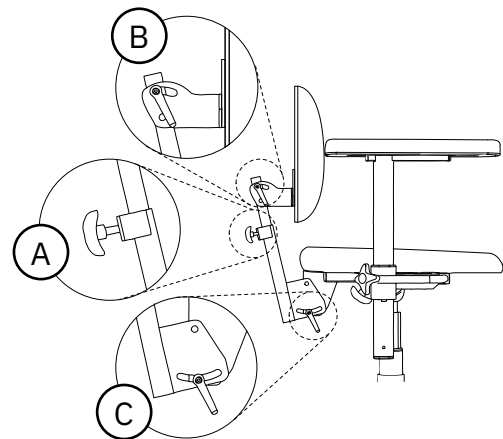

Figure 5.41. Standard backrest mechanism.

### Medic

Medic can be adjusted in height (A), angle of back rest mechanism (B), angle of back recliner (C) and depth (E), see Figure 5.42. The back recliner can be adjusted in the range of 15° forward to 45° backwards.

To set the height and angle of the backrest and back recliner, see Standard back mechanism.

Depth setting:

1. Loosen the knob and adjust to the desired depth.
2. Tighten the knob securely.

**PLEASE NOTE!** Make sure that the Medic backrest mechanism is adjusted in the bracket so the spring button clip locks and the backrest mechanism cannot be pulled out.

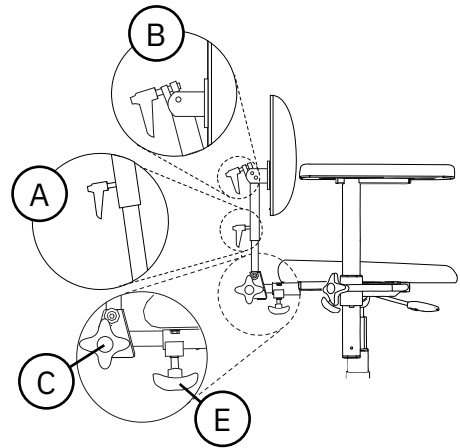

Figure 5.42. Medic backrest mechanism.

### Comfort

Standard can be adjusted in height (A), angle of back rest (B) and has a gas spring-operated back rest mechanism (C), see Figure 5.43. The gas spring-controlled back recliner can be adjusted with the lever under the seat (standard) or the lever under the armrest (optional). The back recliner can be adjusted in the range of 3° forwards to 40° backwards.

To set the height and angle of the backrest, see Standard back mechanism.

The gas spring-controlled back recliner can be set using the control under the seat or armrest:

1. Pull the lever forward if the control is under the seat, or pull up if the control is under the armrest. Tilt your upper body to the desired angle.
2. Release the lever to lock the back recliner.

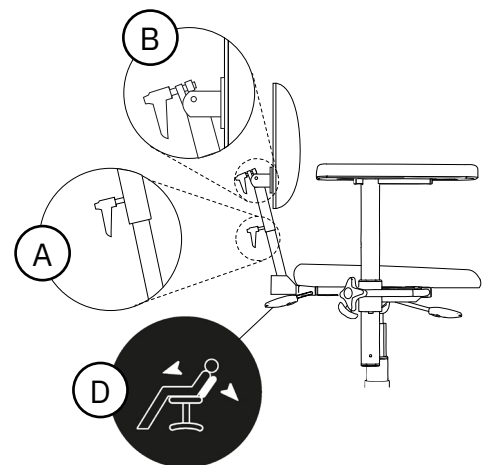

Figure 5.43. Comfort backrest mechanism.

## 5.10. Armrest panel

Armrest panels are available in five versions, Mobile, ErgoMedic, (optional), ErgoMedic Plus (optional), Hemiplegia (optional) and Extra Soft (optional).

Upholstery for armrest panels is available in five materials, synthetic leather, plush (optional), patterned fabric (optional), hygiene fabric (optional) and genuine leather (optional). Real leather is particularly recommended for allergy sufferers. For more information about upholstery, covers and available colours, please visit our website [www.mercado.se](http://www.mercado.se). For an overview of available upholstery and covers, read the document 'Seat systems'.

### Mobile

The Mobile armrest panel is a wide armrest plate with thick foam that provides a stable support when the user is about to sit down and get up, see Figure 5.44. The armrest panel is available in lengths from 250 mm to 400 mm.

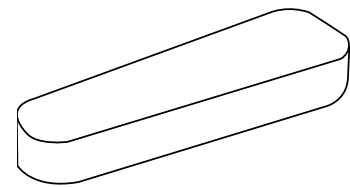

Figure 5.44. Mobile armrest panel.

### ErgoMedic

The ErgoMedic armrest panel is curved at the back to keep the elbow stable. At the front, the armrest panel is shaped to provide a good grip when getting up and transferring, see Figure 5.45. The armrest panel is available in lengths from 250 mm to 400 mm.

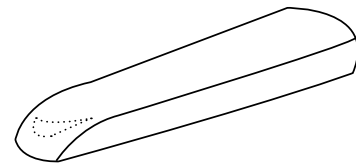

Figure 5.45. ErgoMedic armrest panel.

### ErgoMedic Plus

The ErgoMedic Plus armrest panel is shaped so that the arms are supported from the sides, which means that the upper body is more relieved. The armrest panel is ergonomically shaped at the front to relieve the wrist and carpal bone in a resting position, simultaneously providing the user with good support when sitting down and getting up, see Figure 5.46. The armrest panel also works well as a Hemiplegia armrest. The armrest panel is available in lengths from 300 mm to 420 mm.

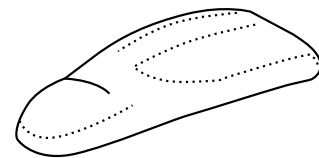

Figure 5.46. ErgoMedic Plus armrest panel.

### Hemiplegia

The Hemiplegia armrest panel is designed for the Hemiplegia armrest (optional) allowing the armrest to be rotated in front of the body. The armrest panel has edges on the outside and inside and is extra long to support the hand, see Figure 5.47. The armrest panel is available in length 450 mm.

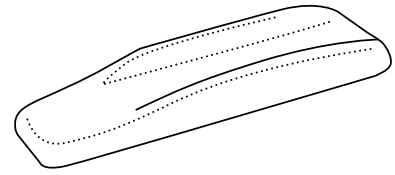

Figure 5.47. Hemiplegia armrest panel.

### Extra Soft

The Extra Soft armrest panel is a slightly wider armrest panel with a very soft and flexible foam. The armrest panel has been designed for pain-sensitive users, but also works for users who sit for long periods of time, see Figure 5.48. The armrest panel is available in lengths from 250 mm to 350 mm.

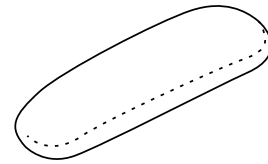

Figure 5.48. Extra Soft armrest panel.

## 5.11. Armrest mechanism

The armrest mechanism is available in three versions, folding armrests, PLUS armrests (optional) and Hemiplegia armrests (optional). The Hemiplegia armrest allows the armrest to be rotated in front of the body. This is for users who have little or no function in the arm or hand.

When using a seat tilt, the armrests can be fitted so that they either move with the seat when it is angled or remain in their original position, see Figure 5.52. Armrests that move with the seat are standard for the electric seat tilt. Armrests that stay in their original position are standard for the manual seat tilt. The Hemiplegia armrest must always be fitted so that it moves with the angle of seat tilt.

### Foldable armrests

Foldable armrests are adjustable in height (A), width (B) and can be folded backwards (C), see Figure 5.49.

For height and width adjustment, see PLUS armrest.

Folding the armrests:

1. Pull out the knob, and if necessary turn it so that it locks in the extended position.
2. Hold the armrest and rotate the armrest backwards to fold it.
3. Rotate the armrest forwards to fold it back.
4. Make sure the knob clicks into the locked position. If the knob does not click in position, rotate the knob until it clicks firmly.

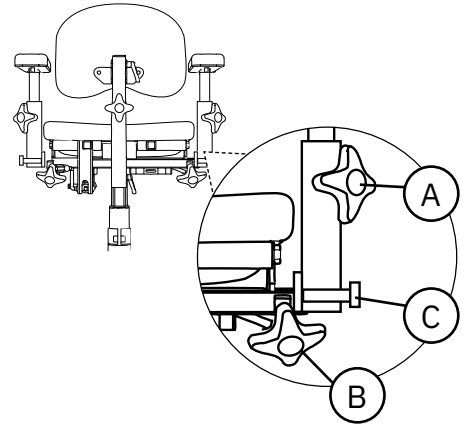

Figure 5.49. Foldable armrests.

### PLUS armrest

The PLUS armrest is adjustable in height (A) and width (B), see Figure 5.50.

Height setting:

1. Loosen the knob and adjust to the desired height.
2. Tighten the knob.

PLEASE NOTE! Tighten the knob fully on the PLUS armrest.

Depth setting:

1. Loosen the knob and adjust to the desired width.
2. Tighten the knob securely.

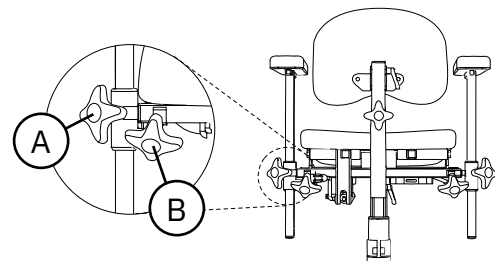

Figure 5.50. PLUS armrest.

PLEASE NOTE! Width adjustment of the armrests should be adjusted by the prescriber, as it may adversely affect the seating ergonomics if this setting is not correct. This particularly applies if the device has side supports fitted.



### Hemiplegia armrest

The Hemiplegia armrest is adjustable in height (A), width (B) and rotation (C), see Figure 5.51.

For height and width adjustment, see PLUS armrest.

Armrest rotation:

1. Loosen the knob and adjust to the desired position.
2. Tighten the knob.

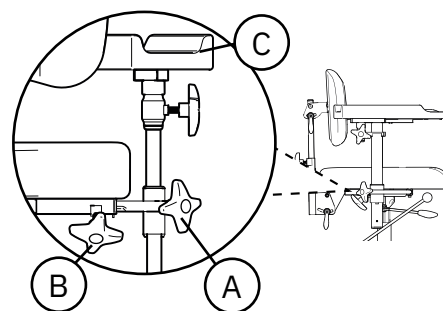

Figure 5.51. Hemiplegia armrest.

### Using the seat tilt

Armrests can be fitted so that they move with the angle of the seat (A) or so that they remain in their original position (B), see Figure 5.52.

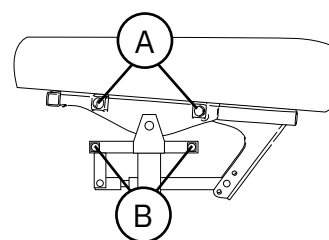

Figure 5.52. Armrest placement when using seat tilt.

## 5.12. Leg support

Manual leg supports are available in two versions, Centre-mounted and Medic. The centre-mounted leg support has a full footplate and is adjustable in height, leg support angle and footplate angle. The angle of the leg support can be adjusted to four different positions. Medic leg support is adjustable in height, angle of leg support and angle of footplate. The leg support is available in models with a full or split footplate. These are available in four sizes, S-XL, with a total range of lengths from 180 mm to 510 mm. The device can be equipped with an optional adapter to be combined with Cross leg support from ETAC (external supplier). Cross leg supports are removable without tools, follow the seat when adjusting height and can be rotated sideways to facilitate entering and exiting. The leg support is available in three models, Standard fixed angle, Tight fixed angle where the angle of the knee becomes closer to 90° and Angular. All models are adjustable in height and angle of footplate and are available with foot plates of different widths.

**Centre-mounted**

The centre leg support is adjustable in height (A), angle of leg support (B) and angle of footplate (C), see Figure 5.53.

Setting the height of the footplate:

1. Loosen the wheel and pull or push the footplate to the desired height.
2. Tighten the knob.

Setting the angle of the leg support:

1. Unscrew the screw with a 5 mm Allen key and set the desired angle.
2. Tighten the screw.

Setting the angle of the footplate:

1. Adjust the screw with 5 mm Allen key.  
Screw clockwise to angle the footplate down.  
Screw anti-clockwise to angle the footplate up.

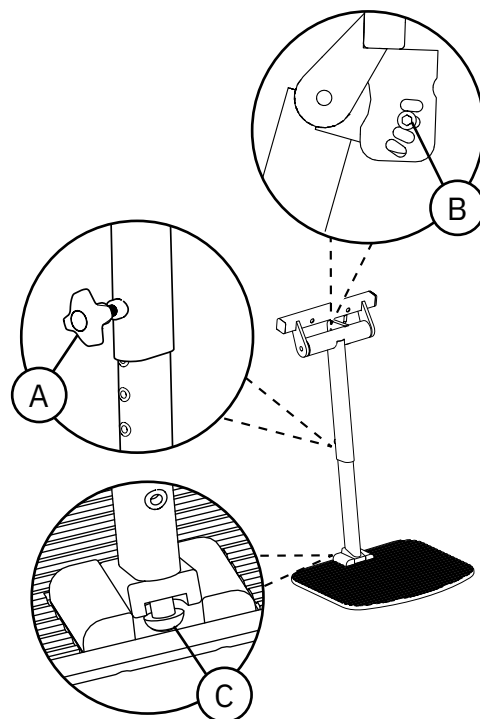

Figure 5.53. Centre-mounted leg support.

**Medic leg support**

The Medic leg support is mounted laterally and adjustable in height (A), angle of leg support (B) and angle of footplate (C), see Figure 5.54.

Height setting:

1. Loosen the screw with a 5 mm Allen key and set the desired angle.
2. Tighten the screw.

Setting the angle of the leg support:

1. Loosen the screw on the clamping joint (B) with 5 mm Allen key and set the desired angle.
2. Tighten the screw.

Setting the angle of the footplate:

1. Loosen the screw on the clamping joint (C) with 5 mm Allen key and set the desired angle.
2. Tighten the screw.

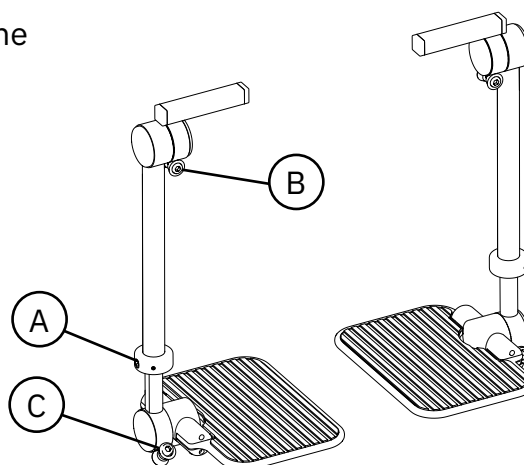

Figure 5.54. Medic leg support.

### Cross leg support adapter

The Cross leg support Adapter, see Figure 5.55, is mounted on the width adjustment bar of the armrests. The adapter can be mounted in two depth positions for different deep seats and be fine-tuned steplessly to 50 mm in depth. For more information, see the installation instructions "Adapter leg support, Cross" available at the [www.mercado.se/en/mercado-document](http://www.mercado.se/en/mercado-document).

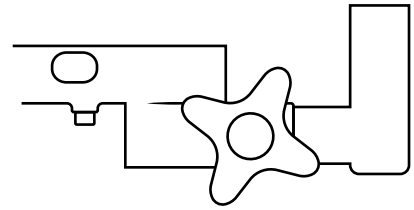

Figure 5.55. Cross leg support adapter.

### Cross leg support

Cross leg supports are removable without tools and can be rotated sideways. Centre leg supports are adjustable in height (A), angle of leg support (B) and angle of footplate (C), see Figure 5.56.

Rotate the leg supports to the side:

1. Lift the leg support straight up about 15 mm and rotate outwards.

Installing the leg support:

1. Insert the leg support into the adapter bracket.
2. Rotate the leg support until it is facing straight ahead and is fixed to the bracket.

Installing a leg support:

1. Lift the leg support out of the adapter bracket.

Setting the height of the footplate:

1. Loosen the wing nut on the back of the leg support tube. Remove the front screw and adjust to the desired length.
2. Insert the screw through the pipe and screw on the wing nut. Tighten the wing nut.

Setting the angle of the footplate:

1. Loosen the two screws on the outside of the footplate 1 to 2 turns with a 5 mm Allen key. Angle the footplate to the desired position.
2. Tighten the screws.

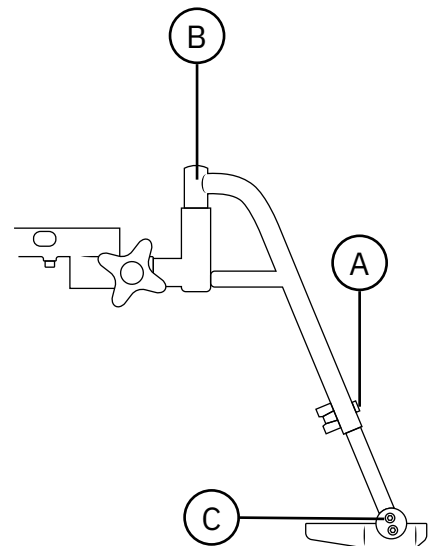

Figure 5.56. Cross leg support.

### 5.13. Chassis

The device is equipped with a complete LiNX f REAL 6100 PLUS chassis. The chassis has four castors with individual suspension and two puncture-free drive wheels. The front legs are spring-mounted to facilitate avoiding obstructions. The spring force and the maximum stroke of the front legs can be individually adjusted. The chassis also includes batteries, drive motors, the power module that is the central point for the product's functions in the control system, controls for application and release of brakes, and a circuit breaker with an ON/OFF function. Releasing the brake allows the device to move manually. The circuit breaker is used to disconnect the batteries, for example when the device is to be transported by air or not used for a long time, see section 3.4. Transport and storage.

If increased stability is needed, the rear leg extensions can be mounted on the device; for more information, see 5.14 Individual customisation.



Warning! The device must never be transported in a vehicle with its brake disengaged. If the device's brake is not applied and it is left on a slope, it will start rolling with the risk of drop or crush damage/injuries as a result.

#### Complete LiNX f REAL 6100 PLUS chassis

A chassis with batteries (A), drive motors (B), power module (C), brake application and release controls (D), and circuit breaker with ON/OFF function (E). The front cover (F) has a cover plug (G), see Figure 5.57.



Warning! The device is equipped with small components such as the cover plug on the front panel. Small parts that have come loose can pose choking hazards for children and pets.

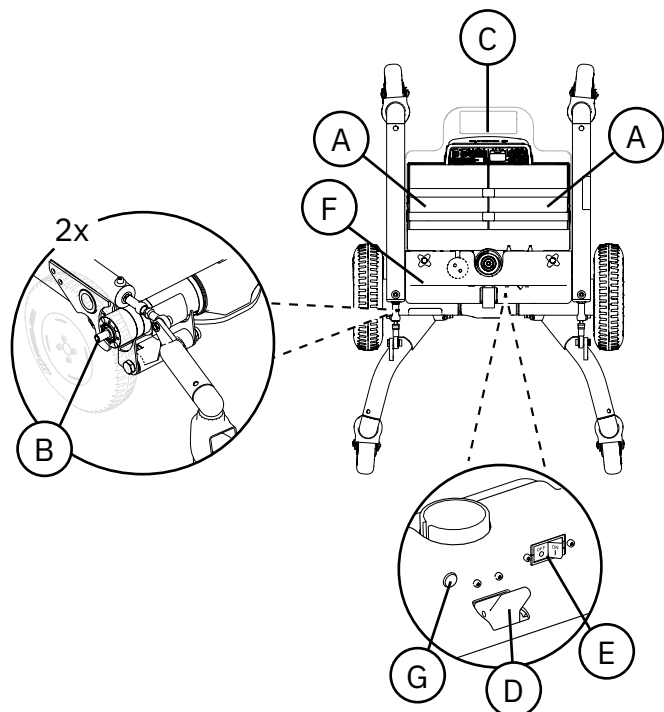

Figure 5.57. Complete LiNX for REAL 6100 PLUS chassis.

**Rear leg extensions**

Rear leg extensions are mounted on the rear legs of the chassis, see Figure 5.58.

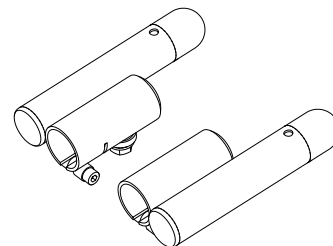

Figure 5.58. Rear leg extensions.

**Contact breaker**

- Press "OFF" to disengage the circuit breaker.
- Press "ON" to reset the circuit breaker.

PLEASE NOTE! After the circuit breaker has been disconnected, the control unit must be restarted twice to restore the device's functions.

**Application and release of brakes**

- To apply the brake, push the lever to the "ON" position.
- To release the brake, pull the lever to the "OFF" position.

PLEASE NOTE! If the brake is released (OFF) when the device is in the ON position, the control box will display an alarm and you will not be able to drive the device. When the brake is re-engaged, the alarm will disappear and the device can be driven again.

## 5.14. Individual adaptation

The device must not be equipped with any accessories or components other than those approved by Mercado Medic. To maintain the CE marking, no individual modifications or changes may be carried out without Mercado Medic's approval. Modifications may be made only by personnel who have completed Mercado Medic's training for servicing and reconditioning.

Mercado Medic's devices are modular and can be customised with various accessories. The components available, as well as how to use them and what they are used for, can be found in the document 'Accessories' on [www.mercado.se/en/mercado-document](http://www.mercado.se/en/mercado-document). All accessories must be mounted and fixed so that they maintain their setting and that there is no possibility for small parts to come loose. All cables must be secured with cable ties to the device's structure to minimise the risk of strangulation.

In addition to its own range, Mercado Medic has combination agreements with several companies. A list of the current companies and components can be found under the Combination Agreements section of [www.mercado.se/en/mercado-document](http://www.mercado.se/en/mercado-document). These items may be assembled while maintaining the CE marking.

If an item that is not on the list of applicable combination agreements is fitted, the responsible organisation must carry out a risk analysis and take over device responsibility from Mercado Medic regarding the specific device. If a third-party item is frequently used on the device, you can contact Mercado Medic with a request for a combination agreement between the supplier of the item in question and Mercado

Medic. The item to be evaluated is sent to Mercado Medic, which evaluates whether combination agreements are up to date. After that, a risk analysis is carried out on the combination as desired. When a risk analysis is carried out, the customer receives a written statement and a new combination agreement is drawn up. The combination agreement is presented on the website [www.mercado.se/en/mercado-document](http://www.mercado.se/en/mercado-document).

If the following guidelines are met when individually adapting authorised personnel of an organisation other than Mercado Medic, then Mercado Medic retains device responsibility for the device.

- Padded parts such as seats, backrests, armrests, side supports, trunk supports and neck supports can be adapted so long as they do not exceed the existing external dimensions of the device.
- The user's centre of gravity must be maintained over the lifting mechanism.
- Padded parts must be able to withstand the applicable flammability requirements and other environmental requirements. If a third-party seat cushion is used, the device must be fitted with a seat mat in anti-slip material of an equivalent size in order to ensure the safety of the device.
- Surfaces that are loaded with significant vertical forces must not fall outside the area (base) that is formed by the centre points of the castors.

devices that have undergone changes outside of the above guidelines must be verified by Mercado Medic in order for Mercado Medic to continue to retain device liability.

For devices specially adapted by healthcare services, outside Mercado Medic's directive, device liability passes to the healthcare services until the device has been restored to original condition or removed from the market. Mercado Medic will then re-assume device liability in accordance with the CE marking Regulation on Medical Devices (EU) 2017/745, MDR.

For questions regarding customisation, please contact the device Manager at Mercado Medic using the contact details of the head office under Section 1.1. Contact details.

## 6. Important safety information

Our website [www.mercado.se](http://www.mercado.se) has information about any safety notices to the market or recalls of devices and accessories.

### 6.1. Standards met and classification

Mercado Medic's work chairs are CE marked in accordance with the Regulation on Medical Devices (EU) 2017/745, MDR, and the Medical Devices Agency's Code of Statutes for Medical Devices LVFS 2003:11. The devices are medical devices as defined in Article 2 of the MDR. The devices are classified as Class 1 non-invasive medical devices in accordance with Regulation 1. The active property of the device variants with electrical functions is not considered to affect the classification.

The device is classified as Class A electric wheelchair, for indoor use only, in accordance with EN 12184:2014. According to the same standard, the weight of the test dummy during all tests was 135 kg.

The devices are tested and approved according to the following standards:

- EN 12184:2014
- ISO 7176-21:2009
- ISO 7176-14:2008

In addition to the above, the battery charger for the device is tested and approved in accordance with the following standards:

- EN 60601-1
- EN 60601-1-2
- EN 60335-2-29:2004 + A2:2010

All textiles on the devices have been tested and approved according to the following fire protection standards:

- EN 1021-1:2014 (ignition source: lit cigarette)
- EN 1021-2:2014 (ignition source: gas flame equivalent to a burning match)

Only the underside of the seat and armrests do not have fire protection as they are wooden. All other surfaces are made of metal or clad in fire protection-rated textiles. Armrests, seats, backrests, etc. have been developed and designed to be free from toxic substances and allergens.

The device complies with IP code IPX4. The figure 4 means that the product is able to withstand being splashed by 10 litres of water per minute at a pressure of 80-100 kPa.

### 6.2. Warnings



Warning! As a user, you should contact your prescriber, technical aids centre or distributor if the device shows reduced or altered performance. A device showing a loss of or change in performance must immediately be taken out of use in order to avoid an accident. The device must not be used again until an authorised technician has examined the device.





Warning! To maintain safety, the device should only be used by the person and purpose for which it is intended. The device is set up for a single user. Changing settings may affect the user's seating position, which may result in damage or injury.



Warning! You are not permitted to modify the device yourself. If you would like individual customisation, contact your prescriber or distributor. If the device is modified, the CE marking no longer applies and Mercado Medic may no longer have full device liability. Modifications may affect the safety of the device and lead to accidents.



Warning! The device may be equipped with long cables or wires that cannot be secured in order for the device to function properly. Cables and wires can pose strangulation risks to small children, for example. Do not leave the device unattended with small children nearby.



Warning! The device is equipped with small components such as the cover plug on the front panel. Small parts that have come loose can pose choking hazards for children and pets.



Warning! Metal surfaces may become very hot if they are exposed to direct sunlight. Skin contact with hot surfaces can lead to burns. Avoid exposing metal surfaces to direct sunlight.



Warning! Always ensure that the device's brake is applied when sitting down and getting up. If the device is not braked, it risks rolling away when you get up or sit down, which can lead to fall injuries.



Warning! Repairs and other technical measures may only be carried out by personnel authorised by Mercado Medic. If this is not followed, the CE marking no longer applies and Mercado Medic may no longer have full device liability.



Warning! The device must not be loaded with loads higher than the maximum user weight. At higher loads, there is a risk that the life of the device will be shortened and components may break. If the device has been subjected to higher loads than intended, authorised personnel should carry out an overall assessment, see 6.3. Expected service life, to ensure that it remains safe to use the device.



Warning! Only tested and approved batteries and chargers from Mercado Medic may be used with models with electrical functions. If using a different charger or different batteries to those which are provided alongside the device by Mercado Medic AB, the CE marking and Mercado Medic AB's device liability will cease to be valid for any cases regarding the battery, charging or other electronics of the device.



Warning! The device must not be equipped with any accessories or components other than those approved by Mercado Medic. To maintain the CE marking, no individual modifications or changes may be carried out without Mercado Medic's approval. See section 5.14 if a non-approved component is going to be used. Individual adaptation.



Warning! Do not plug any electrical accessory, other than those customised by Mercado Medic, into the control system's contacts. Non-adapted components are at risk of breaking and in turn injuring the user. See section 5.14 if a non-approved component is going to be used. Individual adaptation.



Warning! Installation, connection or dismantling is not risk-free. If components are handled incorrectly, for example, crushing damage may occur. This type of work may therefore only be carried out by a Mercado Medic authorised technician.



Warning! All parts of the device must be installed and fixed so that there is no risk of small parts coming loose. All cables must be secured with cable ties to the device's structure to minimise the risk of strangulation.



Warning! Only use chargers approved by Mercado Medic to charge the product. The use of other chargers may, for example, result in the risk of fire or interference with other electronic equipment. See 7. Technical information for approved chargers.



Warning! Chargers with damaged or worn cables and connectors must be immediately removed from service. Worn cables or connectors can lead to short circuits and the risk of fire. Contact your prescriber or distributor to replace the charger, see 1.1 Contact information.



Warning! Batteries emit explosive gases during charging. Consequently, charge your device in well-ventilated area and avoid flames and sparks. There will be a risk of fire if the gases ignite.



Warning! The device must never be transported in a vehicle with its brake disengaged. If the device's brake is not applied and it is left on a slope, it will start rolling with the risk of drop or crush damage/injuries as a result.

### 6.3. Expected service life

The expected service life of the device is ten years when used in accordance with these instructions for use. The expected service life of the device is calculated from the date of manufacture of the device. The date of manufacture of the device can be found on one of the silver-coloured labels on the device's chassis with the format YYYY-MM (year and month), see Figure 6.1. The label also includes serial numbers and an identifier for the device model (UDI-DI).



Figure 6.1. Serial number, UDI-DI and date of manufacture on the label.

NOTE! If the serial number label and the date of manufacture are damaged or destroyed, please contact your prescriber or distributor in the first place for assistance in identifying the device, see 1.1. Contact details. Once the order number or serial number is identified, contact Mercado Medic for a replacement label.

The expected service life of accessories supplied with a Mercado Medic device is 10 years unless otherwise stated in the accompanying documentation.

The expected service life of the device battery is 5 years when the device is charged in accordance with these instructions for use, see 2.3. Charging.

In markets outside Sweden and Norway where a distributor has sold the device directly to the user (where applicable), and therefore there is no responsible prescriber, periodic maintenance must be carried out at least every other year throughout and after the device's entire expected service life. Maintenance should be carried out according to these instructions for use, see page 8. Servicing and reconditioning, in addition to the overall assessment below.

After the expected service life, Mercado Medic cannot guarantee the suitability and safety of the device, as Mercado Medic has no control over how the device has been used and its wear and tear. After the expected service life, Mercado Medic AB cannot guarantee the provision of spare parts.

### Overall assessment

After the expected service life, it is important to make an overall assessment of the device before continuing to use it. The overall assessment of the device shall be carried out by authorised personnel of the healthcare organisation if the device has been prescribed and should at least take into account:

- how the device has been used,
- what condition the device and its components are in,
- whether the device has been reconditioned and serviced,
- when reconditioning and servicing have been carried out,
- what has been remedied on the above occasions,
- and the reason for the above remedial measures.

After the expected service life, periodic maintenance at intervals of a maximum of 2 years shall be carried out according to these instructions for use, see 8. Servicing and reconditioning, in addition to the overall assessment below.

### 6.4. Reporting of adverse events and incidents

As a manufacturer of medical devices in the EU, Mercado Medic is obliged to have a system to monitor how our devices work in practical use.

Before our devices are CE-marked and placed on the market, we have taken into account the risks that may be present with them and taken measures to reduce the risks as far as possible. Nevertheless, accidents and incidents can occur when the devices are used. If this happens, it is important that this is reported to both Mercado Medic and the national relevant authority. Use contact details in these instructions for use for reporting, see 1.1. Contact details. Feel free to use email to enable faster handling.

## 7. Technical information

This section describes the dimensions and performance of the device, as well as symbols that appear on the device.



Warning! Repairs and other technical measures may only be carried out by personnel authorised by Mercado Medic. If this is not followed, the CE marking no longer applies and Mercado Medic may no longer have full device liability.

### User weight

Model	MAX
REAL 6100 PLUS LiNX	135 kg
REAL 6100 PLUS LiNX Child	135 kg



Warning! The device must not be loaded with loads higher than the maximum user weight. At higher loads, there is a risk that the life of the device will be shortened and components may break. If the device has been subjected to higher loads than intended, authorised personnel should carry out an overall assessment, see 6.3 Expected service life, to ensure that it remains safe to use the device.

**Device characteristics for all models**

	REAL 6100 PLUS LiNX	REAL 6100 PLUS Child LiNX
Width <sup>1</sup>	570 mm	
Length	795 mm	
Total height <sup>2</sup>	610–1,040 mm	
Folded height in packaging	550 mm	
Seat height <sup>3</sup>	460–740 mm, 380–580 mm	
Seat cross width	390 mm	340 mm
Seat width	400–480 mm	290–400 mm
Seat depth	390–530 mm	320–480 mm
Seat tilt <sup>4</sup>	0°, -15°/+8°, -8°/+15°, 0°/+23°	
Backrest height	390–650 mm	
Backrest width	350–460 mm	230–360 mm
Back recliner <sup>4</sup>	-15°/+30°, -3°/+40°, -15°/+45°, -23°/+28°	
Leg support length	370–530 mm	310–380 mm
Leg support angle	0°/+32°	
Armrest height	150–300 mm	
Castors	Ø125 mm 804362 Castors Rubber Track 125x36 M12 REAL 6100 PLUS	
Drive wheels	Ø225 mm, fully cast and puncture-free 805203 Drive wheel REAL 6100 PLUS	
Obstacle-negotiating capability	40 mm	
Turning space 180°	870 mm	
Static stability <sup>5</sup>	±6°	
Static lateral stability	6°	
Dynamic stability <sup>6</sup>	Upward gradient 10°, downward gradient 3°	
Maximum speed	4.5 km/h	
Braking distance from maximum speed	1.0 m or 0.7 m with active brake	
Driving distance per charge <sup>7</sup>	approx. 15 km	
Charging time	6–16 hours	

1 Depending on the seat width and the adjustment of the armrests, the device may become wider.

2 Total height with ErgoMedic backrest 380 x 260 mm.

3 These seat heights are achieved with different lifting mechanisms.

4 Negative angle (-) refers to forward tilt and positive angle (+) refers to backward tilt.

5 Seat tilt and back rest back rest mechanism settings together with a high seat height can affect both static and dynamic stability.

6 Reverse the device down a larger downward gradient.

7 This applies to driving conditions with an optimal temperature without obstructions and gradients. PLEASE NOTE! Keep in mind that all electrical seat functions shorten the device's expected distance driven depending on the frequency of use.

Motors	2 x 24 V DC ME803661C 600392 Drive motor Right 6100 PLUS complete 600393 Drive motor Left 6100 PLUS complete
Chargers tested and approved by Mercado Medic AB	ECB-401 EC Buddy 4A BAC1011 Battery charger 6100 Plus UK 4 amp
Batteries tested and approved by Mercado Medic AB	FGS, FGG22805, 2 x 12V 28 Ah BA1020 Battery Pack 24V/28Ah FGS for REAL 6100 PLUS
Weight	76 kg including battery

### Device characteristics for chargers

The device is equipped with an ECB-401 EC Buddy 4A charger. The charger is designed only for lead batteries with 12 cells (24V). The charger should be used at an ambient temperature of 10-30 °C for adequate charging. The optimal charging voltage is available at 20 °C.

The charger is equipped with protection against the following:

- Reverse polarity
- Short-circuiting
- Sparking
- Overheating



Warning! Only use chargers approved by Mercado Medic to charge the product. The use of other chargers may, for example, result in the risk of fire or interference with other electronic equipment. See 7. Technical information for approved chargers.

## 7.1. Programming the device

PLEASE NOTE! Only Mercado Medic authorised personnel may connect up to the device using a coded wireless receiver, LiNX Access Key. For information on training and authorisation, please contact Mercado Medic, see 1.1. Contact details.

### Basic program

At the time of delivery, the REAL 6100 PLUS LiNX has basic software, a bundle program that includes pre-programmed drivers for the device's basic functions as well as drivers for alternative electrical options and accessories. The basic program allows you to switch between the following modules and functions without requiring reprogramming. Restart the device twice after installation to activate the new module or feature.

- REM211 control unit
- REM400 control unit
- REM500 Display box
- LiNX keypad
- Attendant Control (ACU200)
- ACT400 Actuator box for 4 seat functions
- Electric back recliner
- Centre-mounted electric leg support
- Length compensating electric leg support

The bundle program includes more complete programs that can be selected to get alternative features as listed below. The programs are in place (slot) 1 to 4 and can be activated by connecting to the device with the LiNX Access Key. Program 1 is the active basic program on delivery, this is also available as a backup.

**Program 1. Seat functions**

- Seat height
- Seat tilt (option)
- Electric back rest mechanism
- Centre-mounted electric leg support (optional)
- Length adjustment for Optional Length Compensating Electric Leg Support (optional)
- Length and angle for Optional Length Compensatory Electric Leg Support (optional)

**Program 2. Seat functions**

- Seat height
- Seat tilt (option)
- Electric back rest mechanism
- Comfort electric leg support left (optional)
- Comfort electric leg support right (optional)
- Comfort electric leg support left and right (optional)

**Program 3. Seat functions**

- Seat height
- Seat tilt (option)
- Double electric back rest mechanism (optional)
- Centre-mounted electric leg support (optional)
- Length adjustment for Optional Length Compensating Electric Leg Support
- Length and angle for Optional Length Compensatory Electric Leg Support (optional)

**Program 4. Seat functions**

- Seat height
- Seat tilt (option)
- Double electric back rest mechanism (optional)
- Comfort electric leg support left (optional)
- Comfort electric leg support right (optional)
- Comfort electric leg support left and right (optional)

**Customisation of driving functions**

Driving functions must be adapted for the user so that the product can be safely operated with regard to the user's ability and surroundings.

PLEASE NOTE! Customisation of driving functions may only be performed by personnel authorised by Mercado Medic. For information on training and authorisation, please contact Mercado Medic, see 1.1. Contact details.

Selection of programmable functions:

- Maximum forward speed
- Forward acceleration
- Forward braking distance
- Reverse speed
- Reverse acceleration
- Reverse braking distance
- Turning speed
- Turning acceleration





- Braking to turning speed
- Joystick sensitivity
- Use of external joystick
- Reverse joystick function



## 7.2. Symbols

The following symbols are used on the device controls, markings or in these instructions for use. For an overview of the positioning of symbols, see Figure 7.1-7.5.





### No. Manual controls



1		Seat tilt forwards/backwards
2		Back recliner forwards/backwards

### No. Contact breaker







3		OFF
4		ON

### No. Control unit LiNX REM211











5		The symbol is located at the speed control of the LiNX REM211 control unit and indicates the direction to increase or decrease the speed.
6		Horn
7		Function selection up and down, used to select driving and seat functions.
8		Main switch and emergency stop

9		Driving function
10		Seat function
11		Charging symbol

### No. LiNX REM400 & REM500 control unit

12		Main switch and emergency stop
13		Charging symbol
14		Multifunction button I
15		Multifunction button II
16		Symbol of seat functions
17		Horn

**No. LiNX REM400 & REM500 control unit**

18		Navigation button - navigation interaction area and mode symbol with both swipe and touch mode. The symbol is blue if the mode is enabled or grey if the mode is disabled.
19		Symbol for navigation mode with only touch function. The symbol is blue if the mode is enabled or grey if the mode is disabled.
20		Button lock symbol
21		Speed control
22		Locked driving mode symbol – indicates that the chair's driving functions are locked.
23		Restricted driving mode symbol - indicates that the speed of the chair is limited
24		Error code symbol - indicates that an error (with error code 1-7) has occurred
25		Locked seat position symbol - indicates that the seat functions of the chair are locked
26		Bluetooth disabled symbol - indicates Bluetooth pairing feature is disabled
27	J1 	Input for 3.5 mm connector 1 - input for on/off
28	J2 	Input for 3.5 mm connector 2 - function selector input (driving function 1-3)

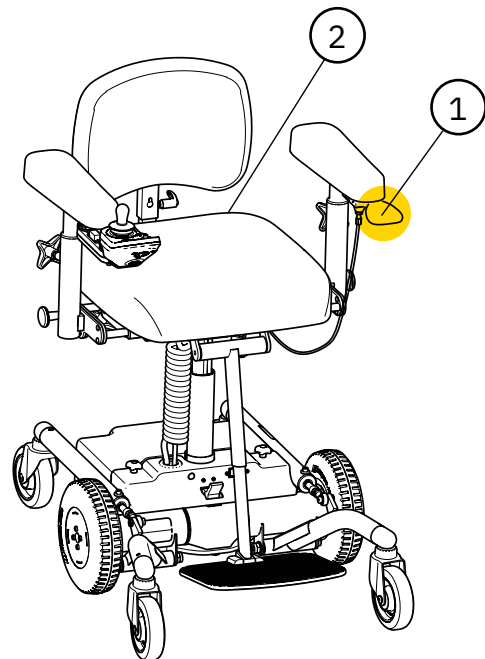

Figure 7.1. Overview of symbols on manual controls.

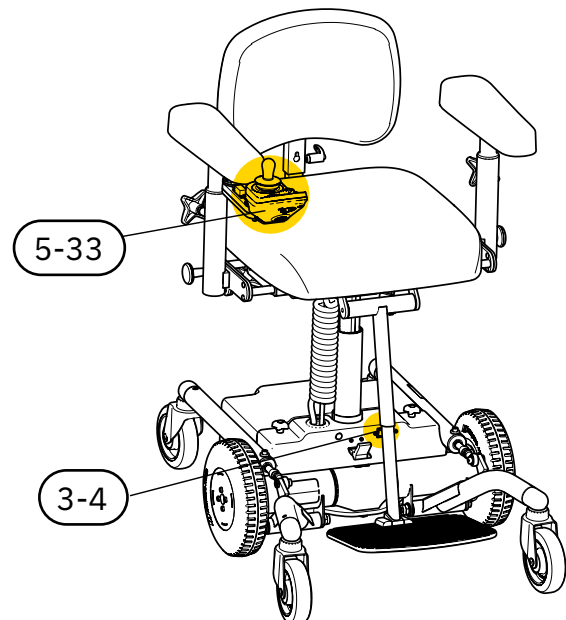

Figure 7.2. Overview of symbols on electric controls.

**No. Electric Controls 10-way switch**

29		Function for adjustment of back angle
30		Function of adjustment of seat height.
31		Function for adjustment of the length of leg supports
32		Function for adjustment of the length and angle of leg supports
33		Function of adjustment seat tilt

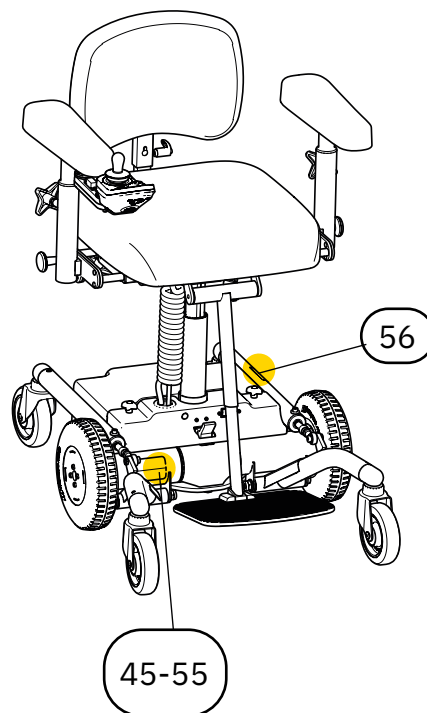

Figure 7.3. Overview of symbols on marking.

**No. Labelling and instructions for use**

34		Warning
35		Not to be ironed
36		Do not use dry cleaning fluid stronger than perchlorine
37		Do not use chlorine bleach
38		Do not tumble dry
39		Machine wash 60°C
40		Protect from moisture
41		Handle with care

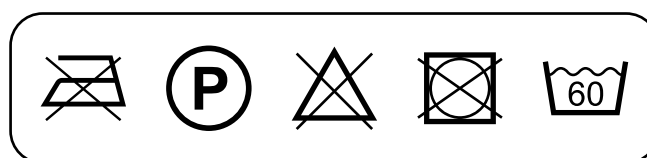

















Figure 7.4. Overview of symbols on laundry care. Symbol 35-39.

**No. Labelling and instructions for use**

42		This side up
43		Permitted temperature
44		Permitted relative humidity
45		Permitted altitude
46		For indoor use only
47		Maximum user weight
48		Date of manufacture
49		Manufacturer
50		Medical device
51		Serial number
52		CE mark showing the device's conformity with the European regulatory framework
53		Electrical components must be disposed of at a special collection point

54		The device is part of a recycling system
55		Component weight exceeds 10 kg
56		May not be used as seat in motor vehicle

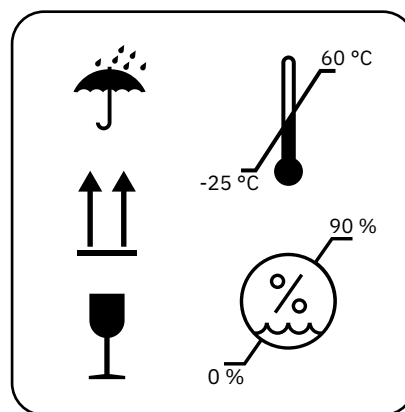

Figure 7.5. Overview of symbols on packaging. Symbol 40-44.

## 8. Servicing & reconditioning

This section describes the inspection and troubleshooting of the device, information about battery replacement and instructions for reconditioning the device. The troubleshooting guide is aimed at all users of the device, and the section is otherwise aimed at those who handle these parts of the device lifecycle professionally.

PLEASE NOTE! The user must not sit in the device while it is being reconditioned or serviced or during maintenance.

### Inspection during service

A thorough visual inspection must be performed of the device's main components in order to guarantee the patient's safety. The device's main components include chassis, lifting mechanism, seat frame, back rest mechanism and armrest mechanism. The inspection must include welds, lockable functions and settings.



Warning! Repairs and other technical measures may only be carried out by personnel authorised by Mercado Medic. If this is not followed, the CE marking no longer applies and Mercado Medic may no longer have full device liability.



Warning! As a user, you should contact your prescriber, technical aids centre or distributor if the device shows reduced or altered performance. A device showing a loss of or change in performance must immediately be taken out of use in order to avoid an accident. The device must not be used again until an authorised technician has examined the device.

### 8.1. Troubleshooting guide

If none of the following actions address the problem that has occurred, service may be required. Please contact your dealer or get in touch with Mercado Medic, see 1.1. Contact details.

#### Operational malfunction of control unit

An operational malfunction is indicated when the control unit indicator light flashes at the main switch. The flashes come in groups of 1-7 at an interval of 2 seconds. The number of flashes indicates the fault that has occurred. The LiNX REM400 control unit and the LiNX REM500 display box also indicate the error code with the number of flashes.

For some faults, the electronics will be reset once the fault has been corrected, and the indicator light will once again show a steady light. Other errors may be connected, which means that the device must be turned off for at least 2 seconds and then be switched on again to reset the error. In the event of serious errors affecting driving safety, the device will automatically stop. Less serious faults will only be indicated by the indicator light and it will be possible to continue driving the device. For less serious faults, the electronics can switch to the backup driving mode. This means that it will still be possible to drive the device, but that all speed variables will be lowered.

Symptom	Cause	Action
1 flash	The control unit is defective.	Reprogram, or replace, control unit.
1 flash	The control unit cabling is broken or incorrectly connected.	Check the control unit cables. Replace the cabling if it is defective.
2 flashes	Cable defective or disconnected.	Check all cables.
2 flashes	Bluetooth connection disconnected.	Check Bluetooth connectivity if active. Check the charger and charge the device's batteries.
2 flashes	Software corrupt.	Reprogramme the system.
2 flashes	Wrong software version.	If signal occurs after changing any module in the system, a software update will be required.
2 flashes	Module defective.	If the error persists after the above actions, the component should be replaced.

3 flashes	Left (M1) motor This means that there is a break or short-circuit on the lead from the electronic module's M1 connector to the motor, or motor 1 is defective.	Check by unplugging the M1 connection and measuring the resistance between the two outer pins (1 and 4) in order to detect any break or short-circuit. Replace the motor if there is a short-circuit.
4 flashes	Right (M2) motor. Short-circuit or breakage of the line from the M2 connector of the electronic module to the motor, or motor 2 is defective.	See 3 flashes, but for the M2 connector.
5 flashes	Left (M1) parking brake The brake is disengaged, or the magnetic sensor is defective.	Check that there is no play in the brake control and that the magnet affects the magnetic sensor when the brake is activated. Also check that the brakes on the motors are actually activated.
5 flashes	Left (M1) parking brake Short circuit or breakage of the line from the M1 connector of the electronic module to the parking brake, or parking brake 1 is defective.	Check by unplugging the M1 connection and measuring the resistance between the two inner pins (2 and 3) in order to detect any break or short-circuit.
6 flashes	Right (M2) parking brake. Short circuit or breakage of the line from the M2 connector of the electronic module to the parking brake, or parking brake 2 is defective.	See 5 flashes, but for the M2 connector.
7 flashes	LiNX Module error. Module or cable defective.	Does not depend on the control unit. Check the connected modules and their cables and connectors. Charge the device's batteries. If the device has become stuck on an uneven surface, ensure that the surface underneath the device is even and then restart the control system. If the error persists, a module may need to be replaced.

Red LED on battery indicator flashes	Battery uncharged/defective.	Charge the device, see 2.3. Charging. Alternatively, replace the battery, see 8.2. Battery replacement.
The functions on the control unit do not work and the red, yellow and green LED are flashing.	The control unit button lock may be activated. The button lock is activated if the main switch is pressed and held for 4 seconds while the device is running.	See 5.3. Control unit for instructions for activating and disabling button locks.

### Operational malfunction of charger

Symptom	Cause	Action
The warning symbol shines with a steady light.	Incorrect polarity to battery.	Contact service.
Warning symbol flashes.	Battery fault.	Contact service.
Strong heat development in connector.	Damaged or worn connector.	Replace both the control unit and the charger.

### Troubleshooting mechanical components

Symptom	Cause	Action
The seat slips in the direction of rotation.	Gap in the lifting mechanism.	Replace the lifting mechanism.
The device runs at low speed in all programs.	Speed reduction micro-switch defective.	Replace the micro-switch.
Noise in the electric lifting mechanism.	Worn bearings.	Replace the electric lifting mechanism.
Electric lifting mechanism not working.	Defective lifting mechanism. Wiring harness disconnected or damaged.	Check cables and connectors. Replace the electric lifting mechanism.
Noise in the castors.	Unlubricated or worn bearings.	Lubricate or replace castors.
Wheels are not moving.	Brake disengaged. Alternatively mechanism for activation and disengaging brake is defective.	Check the mechanism for activating and disengaging brake.
Worn drive tyres.	Worn out drive tyres.	Replace the drive tyres.



## **Event log and statistics**

Event log and device statistics can be used to investigate how the device was being used when an error occurred. For information on training and authorisation, please contact Mercado Medic, see 1.1. Contact details.

### **Event log**

1. Connect to the LiNX system.
2. Save program.
3. Open the event log:
  - a. IOS: Click on Active Errors - Chair Log.
  - b. PC: Click on Chair log; Events will appear in the left column.
4. See the history in the event log. PLEASE NOTE! The log is in chronological order according date and time.
5. Click on an event to obtain additional information about the error and recommended measures.

### **Device statistic (Chair Statistics)**

1. Connect to the LiNX system.
2. Save program.
3. Open the statistics:
  - a. IOS: Then click Active Errors on the right column in Statistics.
  - b. PC: Click on Chair log; Statistics will appear in the right column.
4. See Battery usage for historical charging statistics. Number of deep discharges m.m.
5. Click on an event to obtain additional information.
6. Scroll down to Drive Statistics to see statistics about usage, driving times, etc.

PLEASE NOTE! You can also email a copy of the program to someone else by saving and attaching the file to an email.

## 8.2. Battery replacement



Warning! Repairs and other technical measures may only be carried out by personnel authorised by Mercado Medic. If this is not followed, the CE marking no longer applies and Mercado Medic may no longer have full device liability.

The internal batteries of the device can be replaced. Both batteries in the battery pack must be replaced at the same time. For instructions, see REAL 6100 PLUS Battery Replacement' installation instruction.

### 8.3. Reconditioning and periodic maintenance

The device does not require periodic maintenance in cases where it has a responsible prescriber in the healthcare sector. The prescriber and healthcare organisation are expected to follow up the prescription during the lifetime of the device according to the healthcare procedures. During this follow-up, it is important to question the performance of the device and any perceived changes. Where the device is sold by a distributor directly to the user and does not have the responsible prescriber, periodic maintenance at intervals of a maximum of 2 years must be carried out throughout and after the expected service life according to the following reconditioning instructions.

Reconditioning in these instructions for use does not refer to a full restoration or complete refurbishment in the sense referred to in the Medical Devices Regulation (EU) 2017/745, MDR, with a view to putting the device on the market again with a renewed expected service life. Reconditioning in these instructions for use aims instead at a more comprehensive review and service of the device, but where serial numbers are retained and expected service life remains unaffected. The purpose of this reconditioning may be, for example, to make the device suitable for prescribing to a new user.

#### Inspection during reconditioning

Reconditioning must include a thorough visual inspection of the device's main components in order to guarantee patient safety. The device's main components include chassis, lifting mechanism, seat frame, back rest mechanism and armrest mechanism. The inspection must include welds, lockable functions and settings.

### Replacement of components

On [www.mercado.se](http://www.mercado.se) there are various forms of substrate for changing components, such as exploded diagrams, assembly instructions, connection guides and digital item search. Installation instructions can also be used to disassemble the device's components. For accessories and spare parts please visit our webshop <https://shop.mercado.se/>.



Warning! Installation, connection or dismantling is not risk-free. If components are handled incorrectly, for example, crushing damage may occur. This type of work may therefore only be carried out by a Mercado Medic authorised technician.



Warning! All parts of the device must be installed and fixed so that there is no risk of small parts coming loose. All cables must be secured with cable ties to the device's structure to minimise the risk of strangulation.

### Long-term storage of batteries

In the event of a longer period of storage, disconnect the battery. This is done using the contract breaker. Press "OFF" to disconnect the battery pack. When the battery is disconnected, it must be charged every four months in order to retain its functionality. Before charging, the circuit breaker must be switched on; press "ON". For charging, see 2.3. Charging. If these charging instructions are followed, the battery will maintain sufficient capacity for 5 years.

When the device is to be put back into service, the circuit breaker must be switched on; press "ON". Fully charge the batteries before use.

PLEASE NOTE! Never place a fully discharged battery away for storage. Batteries that are discharged for too long, will be damaged and must be replaced.

### Reconditioning instructions

Do not use high pressure washers when cleaning the device. For instructions on everyday cleaning, see 3. Caring for the device.

The following points should be performed during reconditioning to ensure patient safety:

ID	Area	Reconditioning instructions
<b>1 Cleaning</b>		
1.1	Mechanisms	Clean mechanical parts (not the actuator) using a clean, damp cloth with mild detergent (pH 7-12), surface disinfectant or use a steam cleaner (max. 8 bar).  PLEASE NOTE! Do not wash the device with water or other liquids and chemicals.
1.2	Electronics and cables	Remove dust with a dry cloth.
1.3	Control unit	Wipe the control unit with a cloth lightly moistened with disinfectant. This is so as not to pass on any possible infection.
1.4	Actuator and lifting mechanism	Moving parts are lubricated and should therefore not be cleaned. For lifting mechanisms, see special instructions under section 3.
1.5	Padded parts	Remove and discard all padded parts. Wash any covers according to the washing instructions.
1.6	Castors	Clear the castors of hair and dust.
<b>2 Electrical components</b>		
2.1	Electronics	Connect to the system and check for active errors. Save the program and read through error log and charging statistics. This can be used to estimate the condition of the batteries. Check and, if necessary, fix errors loaded into the log.  PLEASE NOTE! Only Mercado Medic authorised personnel may connect to the system. For information on training and authorisation, please contact Mercado Medic, see 1.1. Contact details.
2.2	Charger	Check that the charger is working and that the casing and cables are undamaged.
2.3	Control unit	Check the functions of the control unit. Check that the joystick bellows is intact and that all buttons are working.

ID	Area	Reconditioning instructions
2.4	ACT400	ACT400 is located on the left side under seat frame. Check that all connected functions are working. Make sure the box is securely attached.
2.5	Contacts	Check that cables and connectors are intact and properly secured. Check that there is no risk of crushing cables and connectors, and that all cables are fastened with cable ties.
2.6	Batteries	Check the batteries' voltage and that there is not too great a difference between the batteries' charge. A large difference in charging may indicate that a battery cell is defective. See REAL 6100 PLUS Battery Replacement installation instructions. Keep in mind that the life expectancy of the batteries is 5 years when maintained according to these instructions for use. This means that it may be time to replace them depending on when the reconditioning is complete and what remedial actions have been taken on the device in the past.
2.7	Electric seat tilt	Check that the actuator is not visibly damaged. Check the function of the actuator's moving parts. Check that all locking screws are tightened to avoid any play in the end position.
2.8	Electric back recliner	Check that the actuator is not visibly damaged. Check the function of the actuator's moving parts. Check that all locking screws are tightened to avoid any play in the end position.
2.9	Electric leg support	Check that the actuator is not visibly damaged. Check the function of the actuator's moving parts. Check that all locking screws are tightened to avoid any play in the end position. Check all joints and make sure that the lower clamping bracket is at the correct level to obtain the correct angular range.
<b>3 Electric lifting mechanism</b>		
3.1	Noise	Listen for noise in the lifting mechanism. Replace the lifting mechanism in case of noise. Load the device and check that the lifting mechanism does not slip when starting from the bottom position. Defective lifting mechanisms can be sent to Mercado Medic for repair.

<b>ID</b>	<b>Area</b>	<b>Reconditioning instructions</b>
3.2	Rotation lock	Make sure that the lifting mechanism does not have any play when rotating or loading from side to side. Replace the lifting mechanism in case of play. Defective lifting mechanisms can be sent to Mercado Medic for repair.
3.3	Lifting columns	Raise the lifting mechanism to the highest position. Wipe the lifting column of dust and dirt with a dry cloth. Then lubricate the lifting column using a thin layer of Teflon or silicone-based grease.
3.4	Attachment	Check that the seat is facing straight ahead relative to the base. Check that the lifting mechanism attachments to the seat frame are correctly assembled and tightened. Replace screws that have damaged key handles or threads.
3.5	Cabling	Inspect cables for any signs of wear, pinching or crushing.
<b>4 Chassis</b>		
4.1	Welds	Check all welds carefully for signs of cracks, corrosion and movement. Ensure good lighting and preferably use a magnifying glass, as small cracks can be difficult to detect on black lacquered bases. Make sure the base is stable. Fill in any paint damage with touch-up paint (item number 801900) to avoid corrosion.
4.2	Bolted joints	Check and tighten all screw joints. Replace screws that have damaged key handles or threads.
<b>5 Application and release of brake</b>		
5.1	Function	Check that there is no play in the brake control and that the magnet affects the magnetic sensor when the brake is activated. Make sure the motors run easily in the disconnected position (OFF).
5.2	Set-up	The mechanism will have to be adjusted if the control does not reconnect correctly.
<b>6 Drive wheels</b>		
6.1	Function	Check that the drive wheels have good tire patterns. Check that the drive wheels have good friction against the floor.
6.2	Bearing	Check that the drive wheels are rolling properly and that there is no play in the gears of the motors.

ID	Area	Reconditioning instructions
<b>7 Castors</b>		
7.1	Function	Check castors and jumpers for wear or play. Wear or play may indicate defective bearings. Check that the castors rotate well and the housings rotate. Replace worn or damaged parts.
7.2	Attachment	Check that the castors' screws are intact and tightened. Replace screws that have damaged key handles or threads.
<b>8 Seat frame</b>		
8.1	Mechanics	Carefully check all welded parts for cracks and paint damage. In particular, check around the mounting of actuators for the seat tilt and at the holes for mounting leg supports, as these areas are particularly subject to load. Ensure good lighting and preferably use a magnifying glass, as small cracks can be difficult to detect on black lacquered structures. Fill in any paint damage with touch-up paint (item number 801900) to avoid corrosion.
8.2	Bolted joints	Check and tighten all screw joints. Replace screws that have damaged key handles or threads.
8.3	Plastic plugs	Check that guide bushings and plastic plugs are properly secured. Replace worn or damaged parts.
8.4	Controls	Make sure that all knobs and handles on the seat frame are working and that they lock correctly.
8.5	Gas spring-controlled seat tilt	If the device is equipped with gas spring controlled seat tilt, check that the gas spring locks the seat tilt properly. If the seat tilt slowly changes under load, adjust the wire nipple. Check and replace damaged wires and sheaths. Check for oil leaks in the gas spring. Replace the gas spring in case of oil leakage.
8.6	Crank-controlled seat tilt	If the chair is equipped with a crank-controlled seat tilt, check that there is no play and that all screws are tightened.
8.7	Coxit mechanics	Make sure that the knobs for the flaps turn easily and are securely locked with the counter nut. If necessary, lubricate the threads with teflon grease or silicone-based lubricant.

ID	Area	Reconditioning instructions
<b>9 Backrest mechanism</b>		
9.1	Mechanics	Check and replace any worn parts, carefully inspect for cracks in welds as they may have been heavily loaded for a long time. Ensure good lighting and preferably use a magnifying glass, as small cracks can be difficult to detect on black lacquered structures. Check that the moving parts work properly.
9.2	Attachment	Make sure that all screws, knobs and handles are easy to move and lock properly. Check that the spring button clips are working flawlessly.
9.3	Plastic plugs	Check that guide bushings and plastic plugs are properly secured. Replace worn or damaged parts.
9.4	Gas spring lever	Check gas pressure and stability in the gas spring. Check that the gas spring locks properly and that the back does not slowly change angle under load. Check and replace damaged wires and sheaths. Check for oil leaks in the gas spring. Replace the gas spring in case of oil leakage.
<b>10 Armrests</b>		
10.1	U-bars	Carefully check the U-bars for cracks and paint damage. Check especially around welds and grooves for the locking, as these areas are particularly subject to load. Ensure good lighting and preferably use a magnifying glass, as small cracks can be difficult to detect on black lacquered structures. Fill in any paint damage with touch-up paint (item number 801900) to avoid corrosion.
10.2	Function	Check and replace any worn parts. Test that locking and function in moving parts are working properly. Check that knobs and screws are working and have no damage to threads or grip surfaces.
10.3	Plastic plugs	Check that guide bushings and plastic plugs are properly secured. Replace worn or damaged parts.
10.4	Armrest mechanics	Check all welds and that there is no damage to mechanical parts that may impair or weaken the structure. Ensure good lighting and preferably use a magnifying glass, as small cracks can be difficult to detect on black lacquered structures. Fill in any paint damage with touch-up paint (item number 801900) to avoid corrosion.



ID	Area	Reconditioning instructions
<b>11 Accessories</b>		
11.1	Restoration	Remove the accessories that should not be attached to the device in the basic version, see 5.2. Basic design.
11.2	Mechanics	Check all welds and that there is no damage to mechanical parts that may impair or weaken the structure. Ensure good lighting and preferably use a magnifying glass, as small cracks can be difficult to detect on black lacquered structures.
11.3	Function	Check and replace any worn parts. Check that the locking and function of moving parts works properly.
<b>12 Programming</b>		
12.1	Software update	<p>Connect to the system and update the electronics with the latest REAL 6100 PLUS LiNX bundle program so that all units in the system have the latest software version. Reset the error log, history and statistics for charging before prescribing the device to a new user.</p> <p>PLEASE NOTE! Only Mercado Medic authorised personnel may connect to the system. For information on training and authorisation, please contact Mercado Medic, see 1.1. Contact details.</p>
<b>13 Final inspection</b>		
13.1	Final inspection	Test all functions of the device. Check that all electric driving and seat functions work according to the basic program.
13.2	Battery sleep mode	If the device is to be kept in stock, the batteries should be fully charged and disconnected using the circuit breaker, see 8.3. Reconditioning and periodic maintenance, Long-term storage of batteries.

## 9. Instructions for destruction

Devices permanently decommissioned must be dismantled and sorted in a correct and safe manner. The website [www.mercado.se/en/mercado-document](http://www.mercado.se/en/mercado-document) there are installation instructions that can also be used to dismantle the device's components. The components should then be discarded in the relevant manner, see 9.1. Recycling sorting.



Warning! Installation, connection or dismantling is not risk-free. If components are handled incorrectly, for example, crushing damage may occur. This type of work may therefore only be carried out by a Mercado Medic authorised technician.

### 9.1. Recycling

Instructions for recycling of components. The maximum component weight is specified for each component. PLEASE NOTE! Component weights may vary depending on configuration.

#### Metal:

- Armrest mechanism (1.8 kg)
- Back mechanism (7.2 kg)
- Head rest mechanism (2.6 kg)
- Leg support (3.3 kg)
- Chassis (22.5 kg)
- Seat frame (7.7 kg)
- Actuator (1.3 kg)
- Lifting mechanism (3.6 kg)
- Gas springs (0.3 kg)
- Other metal parts in devices sold by Mercado Medic AB

#### Electronics:

- Motors (3.2 kg)
- Cables (0.3 kg)
- Power module (0.9 kg)
- Joystick (0.4 kg)
- Actuator box (0.2 kg)

#### Lead battery:

- Batteries (9.7 kg/unit) (discarded batteries should always be taken to environmental recycling centres)

#### Combustible:

- Seat (3.2 kg)
- back rest (4 kg)
- Neck support (0.7 kg)
- Armrest (0.7 kg)
- Other padded parts sold by Mercado Medic

#### Plastics:

- Covers are sorted for disposal in accordance with markings on the plastic. If there is no marking, sort these as combustible items.



