

INSTRUCTIONS FOR USE

for medical work chairs in the REAL 9000 PLUS
device range

Instructions for use and care



UK

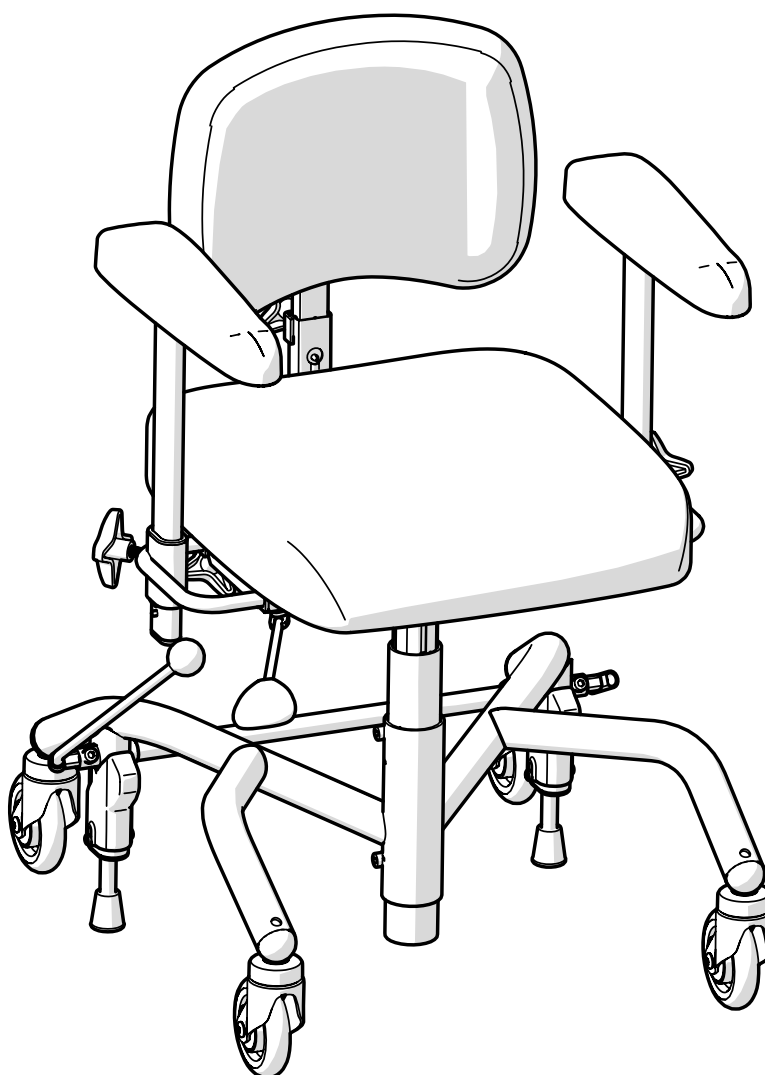

[Space for device label with
serial number]

Table of contents

User information

1. Introduction	4
1.1. Contact details	5
1.2. Warranty	5
2. Getting started	6
2.1. Before use	6
2.2. Electrical and manual height adjustment	9
2.3. Charging	9
2.4. Transfers	10
3. Caring for the device	11
3.1. Padded parts	11
3.2. Castors and brake feet	11
3.3. Other parts	11
3.4. Transport and storage	12

Device information

4. Intended use	13
4.1. Operating environment	13
5. Configurations and settings	14
5.1. Required level of competence for setting and adjusting	14
5.2. Basic design	15
5.3. Electrical functions	16
5.4. Seat	19
5.5. Manual height adjustment	20
5.6. Manual seat tilt	21
5.7. Coxit mechanism	22
5.8. Seat rotation	23
5.9. Backrest	23
5.10. Manual backrest mechanism	25
5.11. Armrest panel	27

5.12. Armrest mechanism	28
5.13. Base	30
5.14. Manual brake	33
5.15. Individual adaptation	34
6. Important safety information	36
6.1. Standards met and classification	36
6.2. Warnings	37
6.3. Expected service life	38
6.4. Reporting of adverse events and incidents	39

Service manual

7. Technical information	40
7.1. Symbols	42
8. Servicing & reconditioning	45
8.1. Troubleshooting guide	46
8.2. Battery replacement	48
8.3. Reconditioning and periodic maintenance	49
9. Instructions for destruction	56
9.1. Recycling	56

1. Introduction

Thank you for choosing Mercado Medic as the supplier of this device. By choosing a REAL chair, you get to learn about a 50-year history of developing medical devices with high function, safety, quality and flexibility. We manufacture all our different medical chairs under our own management in Sweden.

Mercado Medic is certified to ISO 13485, ISO 9001 and ISO 14001, and complies with applicable labour and environmental legislation.

We reserve the right to make changes to this manual and its contents.

Sufficient competence in the safe use of this device is achieved by carefully reading through these instructions for use before using the device for the first time.

PDF versions of our instructions for use with zoom options are always available in their most current version on our website www.mercado.se.



1.1. Contact details

Manufacturer

Street address: Mercado Medic AB,
Tryffelslingan 14, SE-181 57 Lidingö, Sweden

Postal address: Mercado Medic AB,
Box 1074, SE-181 22 Lidingö, Sweden
Tel: +46 (0)8 555 143 00
Email: info@mercado.se
Website: www.mercado.se

Servicing and technical support

Telephone: +46 (0)8 555 143 08
Email: service@mercado.se

To report warranty claims, adverse events and incidents or other feedback please use the form at www.mercado.se/en/support.

Distributor

Responsible person: Henrik Sellberg

Mercado UK Ltd
Repton House, Bretby Business Park,
Ashby Road
DE15 0YZ Burton on Trent
United kingdom

+44 (0)3330 033666
info@mercado-medic.co.uk
www.mercado-medic.co.uk

Space for additional distributor contact details:

1.2. Warranty

All components of Mercado Medic's devices are covered by warranty, under the time periods and general terms and conditions set out below, unless other specific periods and conditions are agreed in writing between Mercado Medic and the contracting customer in connection with major procurements.

As a user, you should contact your prescriber, assistive technology centre or distributor if you experience problems with the device. Distributors in turn should contact Mercado Medic using the contact details available under Section 1.1. Contact details.

Warranty periods

- Metal structures: 3 years.
- Lifting mechanism (electric and gas spring): 2 years.
- Other components (e.g. wheels, batteries, padded parts): 1 year.

General terms and conditions

The warranty does not cover:

- Damage or condition considered to be normal wear and tear.
- Damage caused by negligence or misuse.
- Spare parts, components or accessories not sold by Mercado Medic.
- Adjustments to the device made by unauthorised service technicians.
- Components previously fitted to devices other than the item in question.
- Bleaching or natural variations in the colours of fabrics, synthetic leather and natural leather.

2. Getting started

This section is primarily aimed at you as a user of the device. It describes how to prepare the device for use, adjust the seat height, charge electric models, and how to create good conditions when moving. For care instructions, see 3. Caring for the device.

If you have any questions about your device or if something unexpected has happened, please first contact your prescriber or dealer. You can find up-to-date contact details in Section 1.1. Contact details. You are also welcome to contact us at Mercado Medic.

2.1. Before use

The device is always supplied with a seat, backrest, armrest and brake. When delivered from Mercado Medic, the backrest and brake lever are not yet fitted. These should always be fitted before the device is first used.

Brake lever

Insert the brake lever into the brake lever bracket (A), see Figure 2.1. The brake lever can be placed on the right or left side.

Backrest mechanism

Place the backrest support post in the back recliner (B) and set the desired height level, see Figure 2.1. Tighten all controls (B). The image shows one of several back mechanisms available for Mercado Medic devices. Other back mechanisms are mounted in the same way, although the appearance may differ from that in the image.

Armrests

Loosen the armrest controls (C) and set the desired height and width levels, see Figure 2.1. Tighten all controls (C).

Neck support

If the device is supplied with a neck support, insert the neck support mechanism into the backrest bracket (D) and set the desired height level, see Figure 2.1. Tighten all controls (D).

Battery

Before first use, the battery in electric models must be activated and charged. This is done by connecting the battery charger to the device's charging socket and to a wall outlet (E), see Figure 2.1. The charging socket can be placed in different places on the device. The most common is that the device comes with the charging socket mounted at the rear edge of the left armrest.

Wait until the battery is fully charged before using the device. This normally takes 2 to 5 hours. When the battery is fully charged, the LED on the charger lights up green. For other charging instructions, see 2.3. Charging.

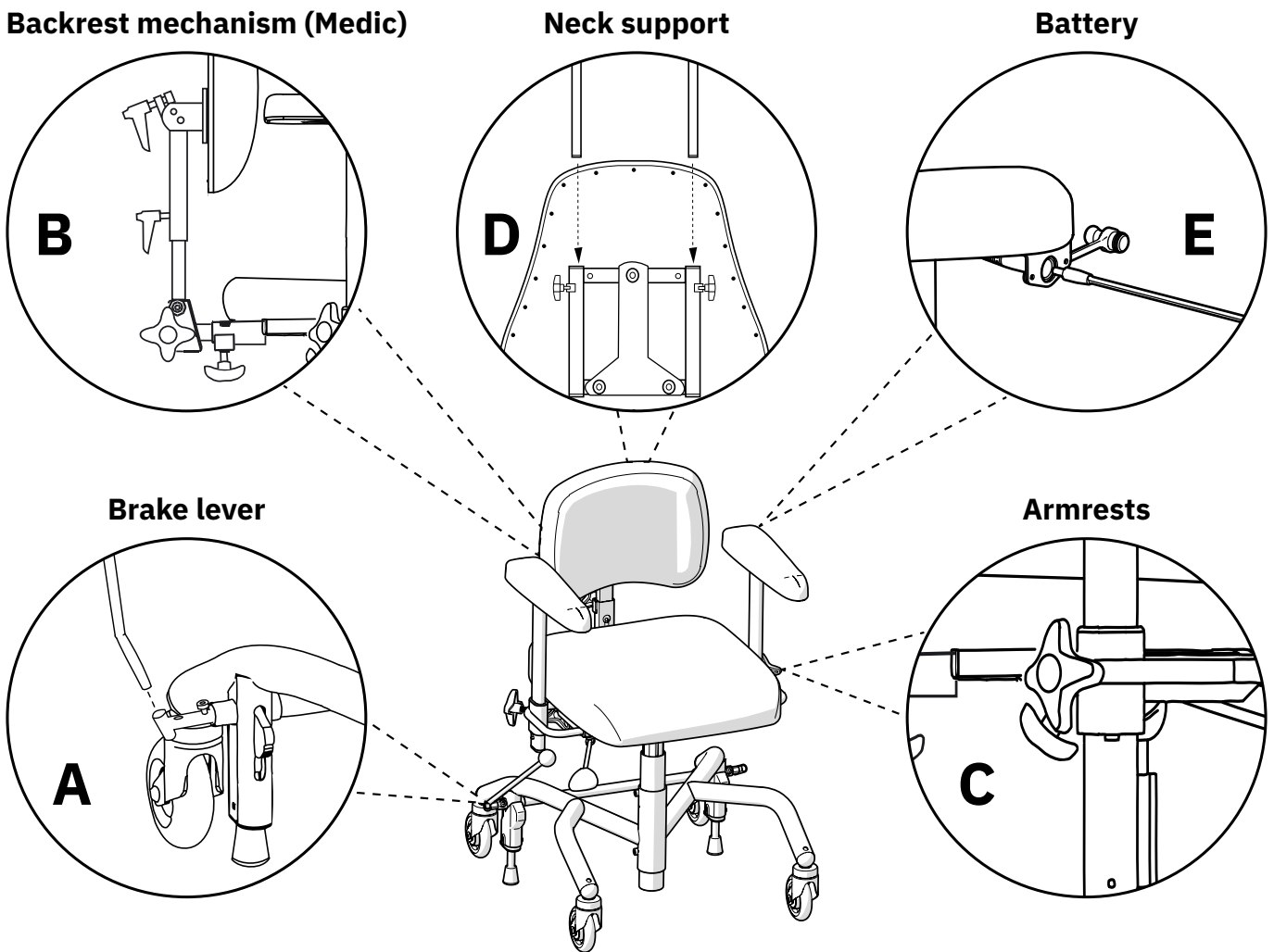

Figure 2.1. Preparations before the device is put into use.

Consider the following before and during use of the device

- All settings controls should be tightened before using the device.
- The device must not be used without fitting the backrest.
- The device must not be used without fitting the armrests.
- The device’s brake must always be applied when sitting down and getting up.
- The braking capacity of the device may be impaired on heavily sloping floors.
- The braking capacity of the device may be impaired on uneven floors.

- The device must be operated with care. Always be aware of your surroundings before moving. Pets or children on the floor could be easily hit.
- The optional foot support ring is designed to rest your feet on, not to stand on.

For models with electrical functions,

- Charge the device according to these instructions for use, see Charging.
- The electrical functions cannot be used when the device is charging.
- If the device is equipped with leg support, your feet should always be in contact with

the footplate when using the electrical functions.

- The seat must never be set to a height where you are unable to get out of the device safely.
- The device must not be moved when the seat is in the raised position.
- Emergency stop for control buttons: If, for whatever reason, the system does not interrupt a movement after the corresponding control button has been released, the movement can be interrupted by pressing the button for movement in another direction.
- Emergency stop for hand-held controller: If, for whatever reason, the system does not interrupt a movement after the corresponding control button has been released, the movement can be interrupted by pressing any of the other buttons on the hand-held controller.
- Button lock on hand-held controller: To enable or disable the button lock for a function, press and hold both of the directional buttons of the relevant function for at least three seconds. The button lock locks only the current function. To lock multiple functions, each function must be locked separately.



Warning! As a user, you should contact your prescriber, technical aids centre or distributor if the device shows reduced or altered performance. A device showing a loss of or change in performance must immediately be taken out of use in order to avoid an accident. The device must not be used again until an authorised technician has examined the device.



Warning! To maintain safety, the device should only be used by the person and purpose for which it is intended. The device is set up for a single user. Changing settings may affect the user's seating position, which may result in damage or injury.



Warning! You are not permitted to modify the device yourself. If you would like individual customisation, contact your prescriber or distributor. If the device is modified, the CE marking no longer applies and Mercado Medic may no longer have full device liability. Modifications may affect the safety of the device and lead to accidents.



Warning! The device may be equipped with long cables or wires that cannot be secured in order for the device to function properly. Cables and wires can pose strangulation risks to small children, for example. Do not leave the device unattended with small children nearby.



Warning! The device is equipped with small parts such as screws that can come loose. Small parts that have come loose can pose choking hazards for children and pets.



Warning! Metal surfaces may become very hot if they are exposed to direct sunlight. Skin contact with hot surfaces can lead to burns. Avoid exposing metal surfaces to direct sunlight.



Warning! Always ensure that the device's brake is applied when sitting down and getting up. If the device is not braked, it risks rolling away when you get up or sit down, which can lead to fall injuries.

2.2. Electrical and manual height adjustment

Depending on the model, the device has electric or manual height adjustment. Electric height adjustment is controlled by the hand-held controller or by the control button located under the right armrest, see Figure 2.2. Manual height adjustment is controlled by controls placed under the seat or under the right armrest, see Figure 2.3. See 5. Configurations and settings for detailed information about all the features and controls of the device.

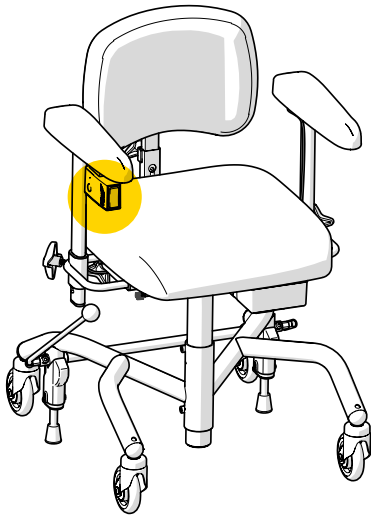

Figure 2.2. Controls on the electric model.

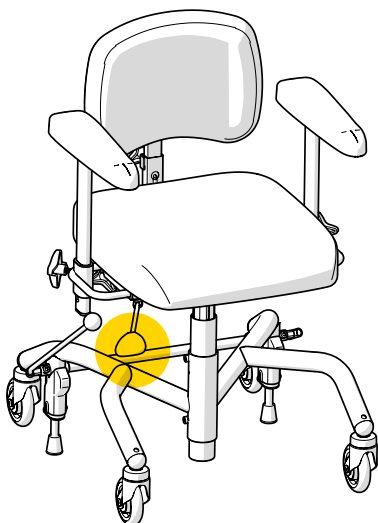

Figure 2.3. Controls on the manual model.

2.3. Charging

For electric models, the battery should be charged once a day. Fully charging the battery on a daily basis will take 2 to 5 hours. It is important that the battery is never completely discharged, as this helps to prolong the life of the battery. Daily charging of the battery is especially important on the configurations with electric brake, electric seat tilt and electric back recliner, to ensure that you as a user can always get in and out of the device safely. The device emits a low battery level warning sound, for both low and critical. Low battery is indicated by a short signal. Critical battery level is indicated by a short signal that ends with a loud beep. If the device is equipped with a hand-held controller, the battery level can also be determined by checking the indicator lights, see Figure 2.4.

The device must be charged in a safe manner. The electrical functions cannot be used when the device is charging. For this reason, choose an easily accessible wall socket to plug the charger into. The charger cable to the wall socket is 1 metre long and must not be extended. In case of emergency, disconnect the device from the mains by unplugging the charger from the wall socket.



Figure 2.4. Battery level indicator on hand-held controller.

How to charge the device

1. Connect the charger plug into the charging socket, see Figure 2.5. The charging socket is normally located at the rear edge of the left armrest, but can also be located under the seat, for example.
2. Connect the charger plug into the wall socket. The LED on the charger will indicate that charging is underway.
3. The battery is fully charged when the LED on the charger changes colour from red to green. If you are using the hand-held controller, this will also be indicated by the three green battery LEDs on the controller, which will start to flash at the same time.

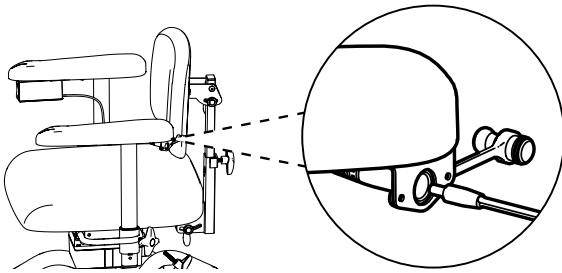

Figure 2.5. Connecting the plug to the charging socket under the armrest.

If the electrical functions have not been used for 7 days, the battery switches off automatically. To reconnect the battery, connect the battery charger to the charging socket and the wall outlet and wait at least 5 seconds before unplugging the charger. It is recommended to charge the battery fully after the battery has been disconnected.

If no electrical functions are working, try charging the battery. If electrical functions still do not work, contact your prescriber or distributor, see 1.1. Contact details.

2.4. Transfers

When moving around while sitting in the device, it is important to make good contact with the floor. For example, rubber-soled indoor shoes can provide better grip and thus facilitate movement. If the device is equipped with seat tilt, and if you have the physical balance to adjust the seat tilt forward slightly, then this can also provide better grip on the floor. A slightly forward-leaning seating position also gives more power in the movement. Rugs and carpets make the movement more difficult. It is therefore recommended to remove rugs or carpets if you want to move while sitting.

When moving across different surfaces, you get more power if you move backwards over thresholds, mouldings and gaps. Lower the seat and, if possible, adjust the seat tilt forward slightly to get over the threshold.



Warning! Always ensure that the device's brake is applied when sitting down and getting up. If the device is not braked, it risks rolling away when you get up or sit down, which can lead to fall injuries.

3. Caring for the device

Clean the device according to the instructions in this section to maintain its functions and service life. If you still have issues that cannot be resolved using available home resources, please contact your prescriber or distributor for reconditioning.

PLEASE NOTE! Do not wash the device with water or other liquids and chemicals.

3.1. Padded parts

To maintain good device hygiene, the device’s padded parts should be cleaned regularly. If padded parts are not regularly cleaned, the device may require reconditioning.

Plush padded parts

Use a foam cleaner to clean plush padded parts. Start by removing any loose debris. Then use a cloth to distribute a thin layer of foam. Wipe with a clean, damp cloth. Finish by vacuuming the upholstery after it has dried.

Synthetic leather padded parts

Use soap and water or surface disinfectant to clean synthetic leather padded parts. Start by removing any loose debris. Then use a cloth to clean the upholstery with soap and water or surface disinfectant. If the upholstery is cleaned using soap and water, finish by wiping with a clean, damp cloth.

Leather padded parts

Use water to clean leather padded parts. Start by removing any loose debris. Then clean the upholstery with a clean, damp cloth. For best effect, padded parts should be cleaned immediately after something is spilled on it. To extend the service life of padded parts, avoid direct contact with chemicals or prolonged sunlight.

3.2. Castors and brake feet

Regular cleaning of castors and brake feet is required to maintain the operation of the device. Wipe castors and brake feet with a damp cloth. Remove any hair from the castors using a thin crochet needle or similar implement.

3.3. Other parts

The device’s lifting mechanism and other actuators, see Figure 3.1 (may be in electric seat tilt, back recliner and brake), should not be cleaned. This is because there is a risk that the grease required for these mechanisms to function as intended might be removed during cleaning.

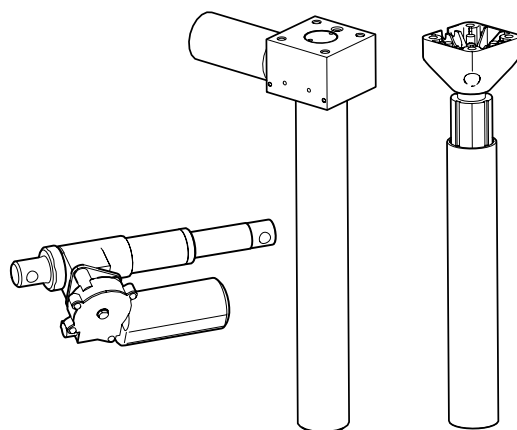

Figure 3.1. Device’s lifting mechanism and other actuators.

If necessary, a dry cloth can be used to remove dust from any electronic parts of the device. Clean the other non-electronic

parts of the device once a week or when necessary. Use a clean, damp cloth with mild detergent (pH 7-12), surface disinfectant or use a steam cleaner (max. 8 bar).

3.4. Transport and storage

When transporting and storing the device, keep the following in mind:

- The device moves by rolling on a flat surface.
- The device should be lifted by two people. Suitable grip points are at the front, rear, right and left sides of the seat, see Figure 3.2.

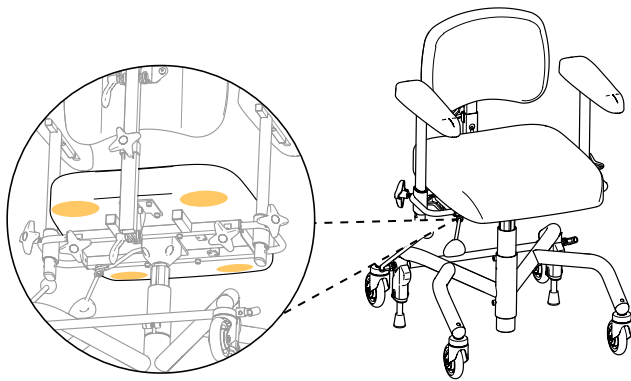
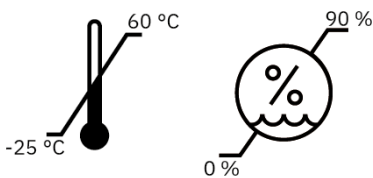

Figure 3.2. Suitable grips when lifting.

over both the base and the seat, and it should be set to the lowest possible seat height. To reduce the size of the device during transport, the backrest can be removed and the armrests lowered. Be sure to select the settings so that they can be easily reset. Tape or similar easily removable marking is recommended.

- The device must not be used as a seat when transported in a car or aircraft, for example.
- In the case of air transport, the device must be stored in the hold. Original Mercado Medic batteries are approved for air transport. For information on battery type, see 7. Technical information.

- The device is intended to be transported and stored at between -25°C to +60°C and up to 90% non-condensing relative humidity.



- The device must be transported in the intended cardboard box on a pallet. If the device is transported by car, it must be strapped in place using straps

4. Intended use

The REAL 9000 device range consists of modular indoor work chairs designed to be used by people who need assistive devices to perform sitting dynamic activities, move by their own power or stand up from sitting. The REAL 9000 intends to make use of the user's physical ability and can therefore be adapted individually in a large number of designs. The device is also intended to be used by passive users who need to correct their seating position to varying degrees. In these cases, the device is configured to be moved and adjusted by an assistant. The device is designed to relieve muscles, joints, bones and relieve pains linked to passivity.

The REAL 9000 is designed and recommended for one or more of the following indications:

- Difficulty or inability to walk.
- Difficulty or inability to stand up from sitting.
- Difficulty in maintaining an adequate seating position.
- Pain or exhaustion as a result of everyday tasks at home or at work.
- Where use of a wheelchair is not suitable as a result of activities of daily living.

Contraindications

There are no known contraindications for use of the REAL 9000. If the device is purchased without prescription from qualified healthcare professionals, the user should consult their doctor whether there are any contraindications.

4.1. Operating environment

- The device is intended for indoor use only and must not be used outdoors.
- The device is intended to be used at between -5°C to +40°C and 15-90% non-condensing relative humidity. If the device is stored in an environment outside these limits, the device must be acclimatised for up to 4 hours to achieve an approved temperature before use.

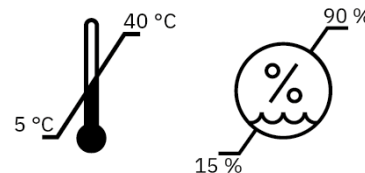

- The device must not be used at altitudes greater than 2000 m above sea level.
- The device must not be exposed to extreme cold or heat, prolonged sunlight or other radiation.
- The device must not be exposed to water, liquids or chemicals to any extent other than that specified in the care information in Section 3. Caring for the device.

5. Configurations and settings

This section is primarily aimed at you as a prescriber of the device. It describes the device's models, options when configuring the device, and information about setting and adjusting the device's functions. For dimensions and performance, see 7. Technical information.

The device is available in several configurable models. The basic design of each model is described below, see 5.2. Basic design. In addition to the basic design, there are a large number of options to personalise the device. For available options, see the description for each function in this section. The models can also be equipped as positioning chairs with, for example, torso support, side support and neck support, and further adapted both inside and outside the CE marking, see 5.15. Individual adaptation. For information about accessories and current combination agreements please visit our website www.mercado.se. For an overview of accessories, read the document 'Accessories'.

The device is compatible with two seating systems, ErgoMedic and ErgoMedic Plus. The seating systems include seats, backrests and armrests. The padded parts can be combined as needed for support, relief and stability when sitting. For users with pain problems, the Slow Recovery variant is available for both seating systems. This variant contains a pressure-relieving foam that is activated by body heat. For specific needs, a seat mat with anti-slip material can be fitted for using third-party seat cushions, see 5.15. Individual adaptation. For more information about the seating systems

and other padded parts, please visit our website www.mercado.se. For an overview of available upholstered details, read the document 'Seat systems'.

On www.mercado.se there are various forms of prescription support such as information sheets, order forms and a digital chair configurator. There are also instructions for use and device information for all Mercado Medic devices.

5.1. Required level of competence for setting and adjusting

The functions and accessories for positioning and relief sitting should only be set by the prescriber of the device unless otherwise agreed, as this requires knowledge of good sitting positions. These features and accessories include neck support, trunk support, side support, Coxit mechanism, leg support and width adjustment of armrests.

Daily functions, such as adjusting the seat height, seat tilt, brake, gas spring-controlled back recliner and armrest height can be adjusted by the user themselves where appropriate and if this can be done safely.

5.2. Basic design

The device is always supplied with seat, backrest, armrests, base with four castors (100 mm as standard), manual brake with brake lever (350 mm as standard) and an angular seat frame that does not allow seat tilt. Depending on the model, the device has either electric or manual height adjustment.

PLEASE NOTE! The basic design of the device may vary between regions and contracting entities.

REAL 9000 PLUS

Adult model with manual height adjustment.

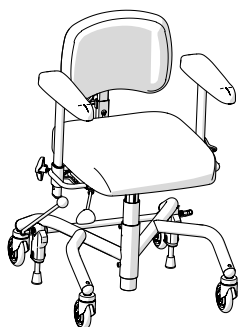

REAL 9100 PLUS EL 24V

Adult model with electric height adjustment.

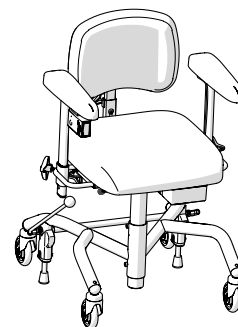

REAL 9300 PLUS

Child model with manual height adjustment.

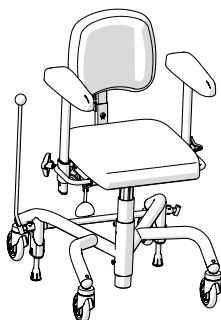

REAL 9400 PLUS EL 24V

Child model with electric height adjustment.

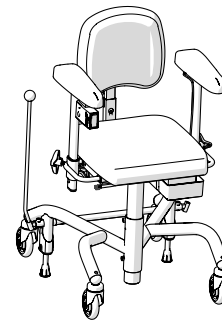

REAL 9700 PLUS

Coxit adult model with manual height adjustment.

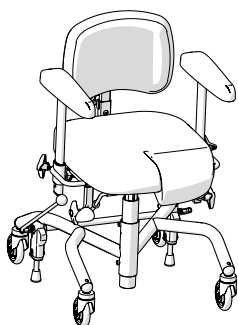

REAL 9800 PLUS EL 24V

Coxit adult model with electric height adjustment.

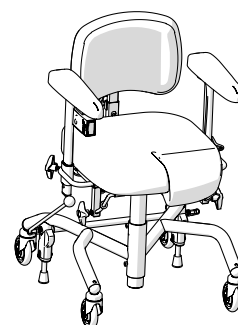

EVI

Manual child model with high-low function for the smallest.

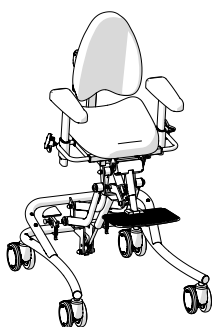

5.3. Electrical functions

Electric models can be equipped with up to four electrical functions, electric height adjustment, electric brake (optional), electric seat tilt (optional) and electric back recliner (optional). These can be adjusted in two ways; either using the control button located under the armrest or with the hand-held controller.

The functions of electric height adjustment and electric seat tilt can be used at the same time¹ and will then act as an aid to getting up. This is made easier by allowing the user to raise the seat and keep their feet on the floor for the whole movement up. It also provides more controlled support when the user sits down.

Control button

The control button is an electric control with three positions (off, up and down), which can be used to adjust seat height, seat tilt or back recliner. With the option of several electrical functions, the device is equipped with several control buttons. If the device is equipped with an electric brake, there is a special control button with two positions (sleep mode and switch between activated and deactivated) for this.

Seat height

The seat height control button is located under the front edge of the right armrest, see Figure 5.1.

Adjustment:

1. Press up for upward movement.
2. Press down for downward movement.

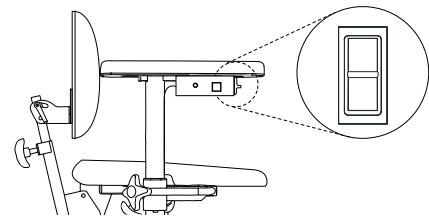

Figure 5.1. Control button for adjusting seat height.

Brake

The brake control button is located on the outside under the right armrest, see Figure 5.2.

Activation and deactivation of brake:

1. A short press activates the brake.
2. A short press on the same button deactivates the brake.

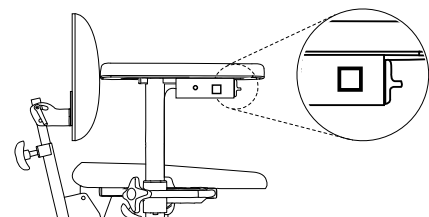

Figure 5.2. Control button for activation and deactivation of brake.

¹ Only applies to electric models supplied from 2021-05-26.

Seat tilt

The seat tilt control button is located under the front edge of the left armrest, see Figure 5.3.

Adjustment:

1. Press up for backward seat tilt.
2. Press down for forward seat tilt.

PLEASE NOTE! If the device is equipped with all four electrical functions, a seat tilt control button and a back recliner control button are located on the same armrest next to each other.

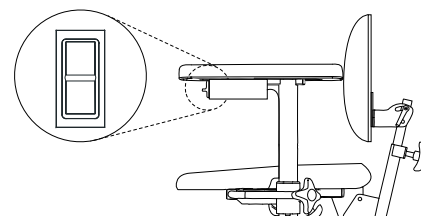

Figure 5.3. Control button for adjusting seat tilt.

Back recliner

The back recliner control button is located under the front edge of the left armrest, see Figure 5.4.

Adjustment:

1. Press up to move the back recliner backwards.
2. Press down to move the back recliner forwards.

PLEASE NOTE! If the device is equipped with all four electrical functions, a seat tilt control button and a back recliner control button are located on the same armrest next to each other.

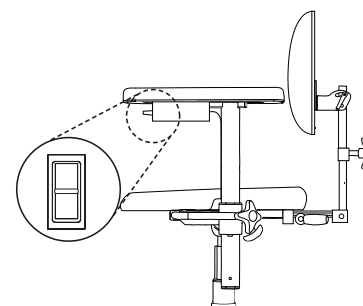

Figure 5.4. Control button for adjusting back recliner.

Hand-held controller

The hand-held controller (optional) is available in two versions, wired controller and wireless remote control. These are available in models with 1 function or 4 functions. The 1-function is intended to only control raising and lowering. The 4-function can control all four functions. The hand-held controller also has a button lock function, see Figure 5.9.

Seat height

Buttons on the upper keypad on the left, see Figure 5.5.

Adjustment:

1. Press up for upward movement.
2. Press down for downward movement.

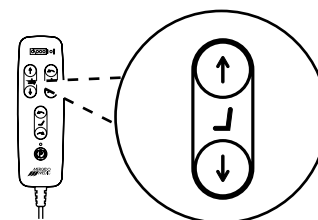

Figure 5.5. Button for adjusting seat height.

Brake

Button in the middle at the bottom, see Figure 5.6.

Activation and deactivation of brake:

1. A short press activates the brake.
2. A short press on the same button deactivates the brake.

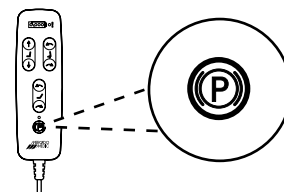

Figure 5.6. Button for activation and deactivation of brake.

Seat tilt

Buttons on the upper keypad on the right, see Figure 5.7.

Adjustment:

1. Press up for forward seat tilt.
2. Press down for backward seat tilt.

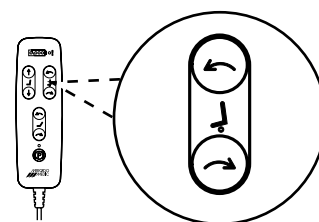

Figure 5.7. Button for adjusting seat tilt.

Back recliner

Buttons in the middle on the lower keypad, see Figure 5.8.

Adjustment:

1. Press up to move the back recliner forwards.
2. Press down to move the back recliner backwards.

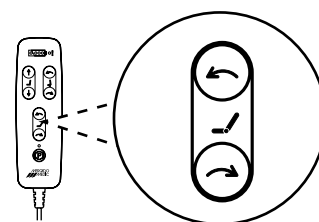

Figure 5.8. Button for adjusting back recliner.

Button lock

Activating and deactivating the button lock:

1. To activate the button lock, press and hold both of the directional buttons of the relevant function for at least three seconds.
2. To deactivate the button lock, press and hold both of the directional buttons of the relevant function again for at least three seconds.

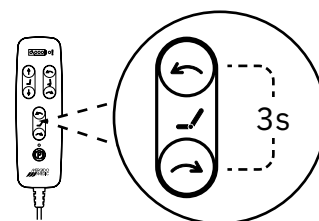

Figure 5.9. Examples of activation or deactivation of button locks for back recliner.

PLEASE NOTE! The button lock only locks and unlocks the function that has locked buttons. To lock multiple functions, each function must be locked separately.

5.4. Seat

Seats are available in three versions, ErgoMedic, ErgoMedic Plus and ErgoMedic Plus Coxit. These are also available with the optional Slow Recovery padding.

Seat upholstery is available in four materials: plush, synthetic leather (optional), patterned fabric (optional) and hygiene fabric (optional). Upholstery in hygiene fabric is used to protect the seat from moisture. Plush and hygiene fabric covers (optional) are also available for all seat designs and sizes. Hygienic fabric covers have a plush exterior and a plasticised interior. For more information about upholstery, covers and available colours, please visit our website www.mercado.se. For an overview of available upholstery and covers, read the document 'Seat systems'.

ErgoMedic

ErgoMedic is a flat seat with seat indent and extra support under the thighs, see Figure 5.10. The seat is available in sizes from 290 x 320 mm to 480 x 530 mm.

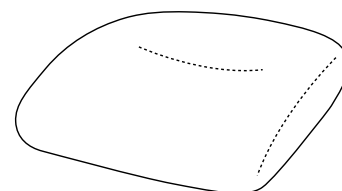

Figure 5.10. ErgoMedic seat.

ErgoMedic Plus

ErgoMedic Plus is a more positioning seat with raised sides for better relief, see Figure 5.11. The seat is available in sizes from 290 x 320 mm to 480 x 530 mm.

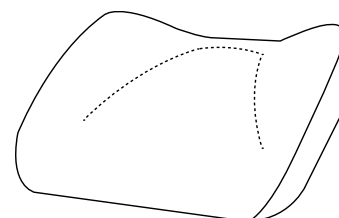

Figure 5.11. ErgoMedic Plus seat.

ErgoMedic Coxit

ErgoMedic Coxit is a seat with angle-adjustable flaps, see Figure 5.12. The seat is available in sizes from 400 x 390 mm to 440 x 480 mm.

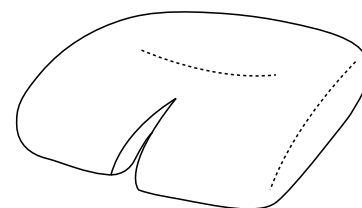

Figure 5.12. ErgoMedic Coxit seat.

ErgoMedic Plus Coxit

ErgoMedic Plus Coxit is a more positioning seat with angle-adjustable flaps and raised sides for better relief, see Figure 5.13. The seat is available in sizes from 400 x 390 mm to 440 x 480 mm.

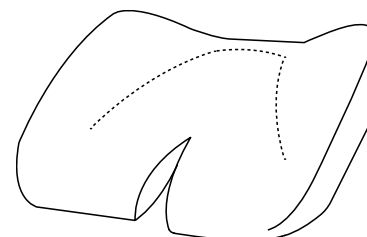

Figure 5.13. ErgoMedic Plus Coxit seat.

5.5. Manual height adjustment

Manual height adjustment is available in two ranges, standard seat height and low seat height. These are also available for three different user weight ranges 0 - 55 kg, 55 - 90 kg and 90 - 150 kg. Manual height adjustment uses a gas spring lever. Height adjustment is also available as an electrical function, see 5.3. Electrical functions.

PLEASE NOTE! Lightweight users may need help raising and lowering the gas spring controlled height adjustment.

Gas spring lever

The height adjustment lever can be placed under the seat (standard) or under the armrests (optional). The lever can be placed on the right or left side, see Figure 5.14.

Adjustment:

1. Pull the lever upwards to disengage the gas spring driven lifting mechanism, then select the desired height with your feet on the floor.
2. Lock the height by releasing the lever.

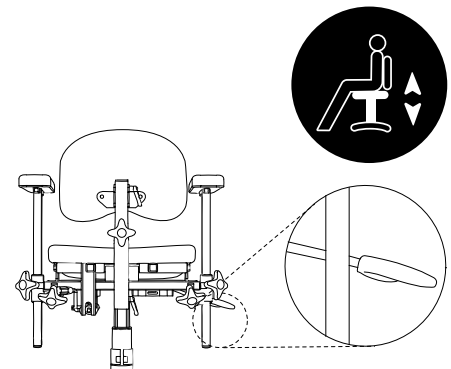

Figure 5.14. Gas spring lever for height adjustment.

5.6. Manual seat tilt

Manual seat tilt (optional) is available in three ranges: standard (15° forward, 8° backward), reverse seat tilt (8° forward, 15° backward) and all seat tilt backwards (0° forward, 23° backwards). If selecting the option of all seat tilt backwards (0° forwards, 23° backwards), the device must be equipped with a base extender, see 5.13. Base. The device can also be configured prepared for seat tilt with a fixed brace that fixes the seat tilt in a flat position (0°). Manual seat tilt can be adjusted with the crank handle or gas spring lever. Height adjustment is also available as an electrical function, see 5.3. Electrical functions.

Gas spring lever

The lever for the gas spring can be located on the left rear edge of the seat or under the armrest, see Figure 5.15.

Adjustment:

1. Lift and hold the lever to disengage the gas spring, adjust the seat tilt by moving your upper body weight forwards and backwards until the desired position is reached.
2. Release the lever to lock the seat tilt.

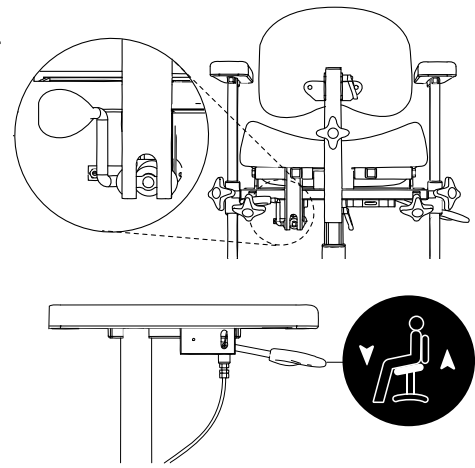

Figure 5.15. Gas spring lever for adjusting seat tilt.

Crank handle

The crank handle is placed under the rear edge of the seat, see Figure 5.16.

Adjustment:

1. Turn the control to the right to move the seat tilt forwards.
2. Turn it to the left to move the seat tilt backwards.

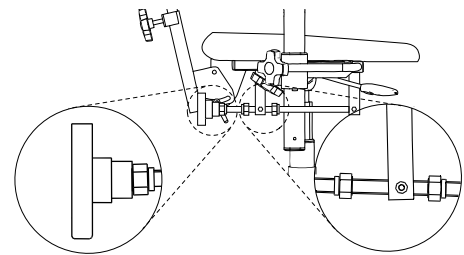

Figure 5.16. Crank handle for adjusting seat tilt.

5.7. Coxit mechanism

The Coxit mechanism has angle-adjustable flaps that can be angled down to a maximum of 45°. The flaps are set using a knob.

On configurations without the seat silt, Coxit mechanism controls are placed under the front edge of the seat on the right and left sides, see Figure 5.17. On configurations with the seat tilt, Coxit mechanism controls are placed under the rear edge of the seat on the right and left sides, see Figure 5.18.

Coxit mechanism with controls under the front edge of the seat

Adjustment:

1. Loosen the knob, set the desired angle on the flap.
2. Tighten the wheel.

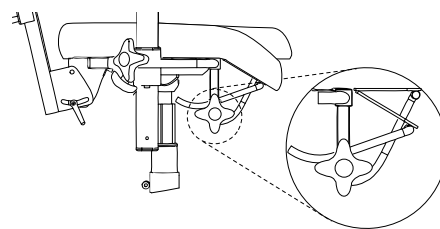

Figure 5.17. Control under the front edge of the seat for setting the Coxit mechanism.

Coxit mechanism with control under the rear edge of the seat

Adjustment:

1. Rotate the knob clockwise to lower the flap.
2. Rotate the knob anticlockwise to raise the flap.

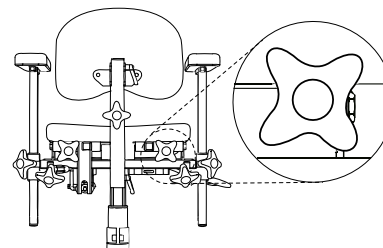

Figure 5.18. Control under the rear edge of the seat for setting the Coxit mechanism.

5.8. Seat rotation

Seat rotation (optional) allows the seat to be rotated relative to the base in ranges between +90° to -90°.

Seat rotation

The rotation control (A) is placed under the seat on the right side, see Figure 5.19.

Activation and deactivation:

1. Turn the control clockwise to disengage.
2. Turn the control anticlockwise to lock. Feel the seat in the direction of rotation to check that the rotation lock is secured in the locked position.

PLEASE NOTE! The rotation must be locked in position when getting in and out of the chair.

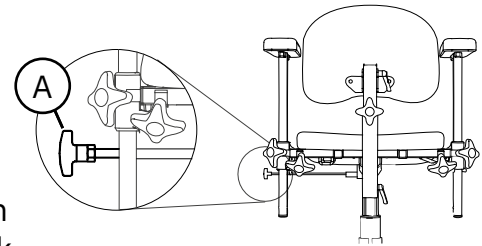

Figure 5.19. Seat rotation control.

5.9. Backrest

Backrests are available in six versions: ErgoMedic, ErgoMedic Support (optional), ErgoMedic Plus (optional), ErgoMedic Plus with side wedge (optional), ErgoMedic Plus Comfort (optional) and ErgoMedic Plus Comfort with side wedge (optional). ErgoMedic and ErgoMedic Plus are also available in the optional Slow Recovery material. ErgoMedic Plus with side wedge is also available with reinforced side wedges (optional).

Backrest upholstery is available in four materials: plush, synthetic leather (optional), patterned fabric (optional) and hygiene fabric (optional). Plush and hygiene fabric covers (optional) are also available for all seat designs and sizes. Hygienic fabric covers have a plush exterior and a plasticised interior. For more information about upholstery, covers and available colours, please visit our website www.mercado.se. For an overview of available upholstery and covers, read the document 'Seat systems'.

ErgoMedic

ErgoMedic is a lightly curved backrest, see Figure 5.20. The seat is available in sizes from 270 x 220 mm to 460 x 430 mm.

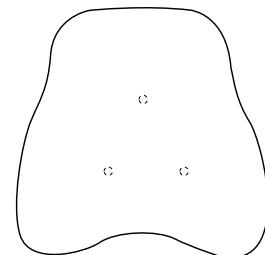

Figure 5.20. ErgoMedic backrest.

ErgoMedic Support

ErgoMedic Support is a lightly curved backrest with more padding and an extra built-up lumbar support, see Figure 5.21. The seat is available in sizes from 350 x 430 mm to 460 x 430 mm.

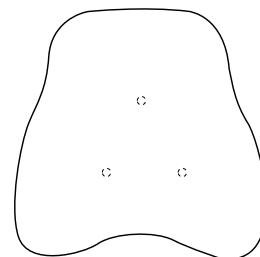

Figure 5.21. ErgoMedic Support backrest.

ErgoMedic Plus

ErgoMedic Plus is a more positioning backrest with built-up sides for better support, see Figure 5.22. The seat is available in sizes from 230 x 200 mm to 460 x 430 mm.

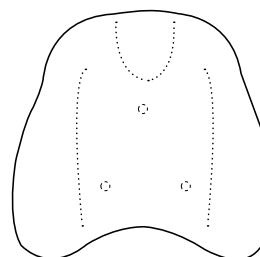

Figure 5.22. ErgoMedic Plus backrest.

ErgoMedic Plus with side wedges

ErgoMedic Plus with side wedges is a highly positioning backrest with extra built-up sides for better lateral stability, see Figure 5.23. The seat is available in sizes from 300 x 340 mm to 460 x 430 mm.

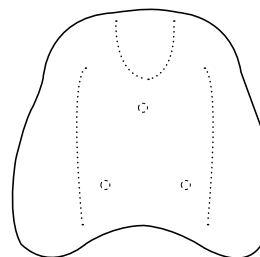

Figure 5.23. ErgoMedic Plus backrest with side wedges.

ErgoMedic Plus Comfort

ErgoMedic Plus Comfort is a more positioning backrest with built-up sides for better support, see Figure 5.24. The backrest also has adjustable lumbar support that provides extra support in the lumbar spine. The lumbar support is adjusted with a pump. The seat is available in sizes from 350 x 430 mm to 460 x 430 mm.

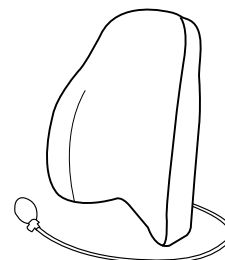

Figure 5.24. ErgoMedic Plus Comfort backrest.

ErgoMedic Plus Comfort with side wedges

ErgoMedic Plus Comfort with side wedges is a highly positioning backrest with extra built-up sides for better lateral stability, see Figure 5.25. The backrest also has adjustable lumbar support that provides extra support in the lumbar spine. The lumbar support is adjusted with a pump. The seat is available in sizes from 350 x 430 mm to 460 x 430 mm.

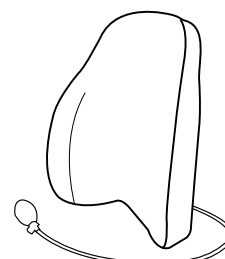

Figure 5.25. ErgoMedic Plus Comfort backrest with side wedges.

5.10. Manual backrest mechanism

The manual back mechanism is available in three versions, Standard, Medic (optional) and Comfort (optional). These are available in low and high models. Back recliner adjustment is also available as an electrical function, see 5.3. Electrical functions.

PLEASE NOTE! The illustrated back mechanisms are in the low model.

Standard

Standard can be adjusted in height (A), angle of backrest (B) and angle of back recliner (C), see Figure 5.26. The back recliner can be adjusted in the range of 15° forward to 30° backwards.

Height setting:

1. Loosen the knob and select the desired height for the back.
2. Tighten the knob.

Setting the angle of the backrest:

1. Loosen the handle and adjust to the desired angle.
2. Tighten the handle.

Setting the angle of the back recliner:

1. Loosen the knob and adjust to the desired angle.
2. Tighten the knob securely.

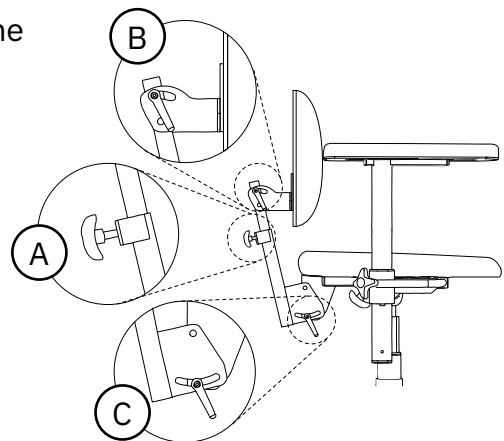

Figure 5.26. Standard backrest mechanism.

Medic

Medic can be adjusted in height (A), angle of backrest (B), angle of back recliner (C) and depth (E), see Figure 5.28. The back recliner can be adjusted in the range of 15° forward to 45° backwards.

To set the height and angle of the backrest and back recliner, see Standard back mechanism.

Depth setting:

1. Loosen the knob and adjust to the desired depth.
2. Tighten the knob securely.

PLEASE NOTE! Make sure that the Medic backrest mechanism is adjusted in the bracket so the spring button clip locks and the backrest mechanism cannot be pulled out.

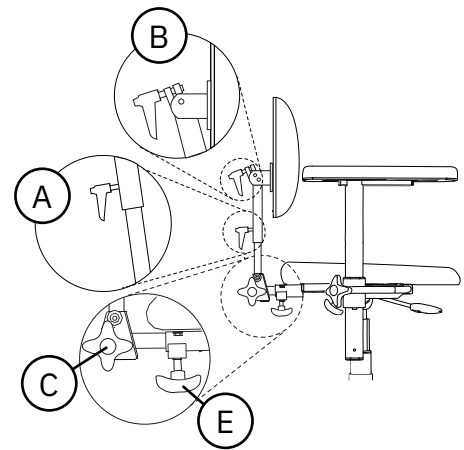

Figure 5.28. Medic backrest mechanism.

Comfort

Standard can be adjusted in height (A), angle of backrest (B) and angle of back recliner (C), see Figure 5.27. The gas spring-controlled back recliner can be adjusted with the lever under the seat (standard) or the lever under the armrest (optional). The back recliner can be adjusted in the range of 3° forwards to 40° backwards.

To set the height and angle of the backrest, see Standard back mechanism.

The gas spring-controlled back recliner can be set using the control under the seat or armrest:

1. Pull the lever forward if the control is under the seat, or pull up if the control is under the armrest. Tilt your upper body to the desired angle.
2. Release the lever to lock the back recliner.

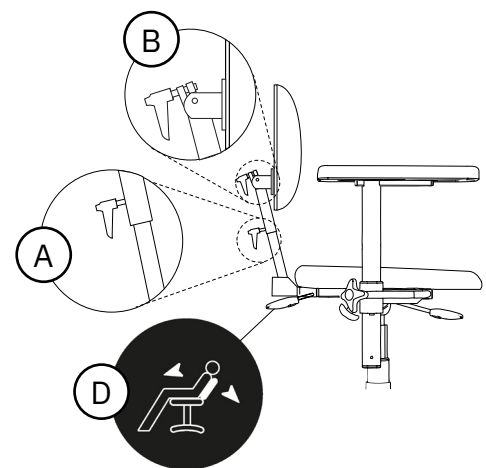

Figure 5.27. Comfort backrest mechanism.

5.11. Armrest panel

Armrest panels are available in five versions, ErgoMedic, Mobile (optional), ErgoMedic Plus (optional), Hemiplegia (optional) and Extra Soft (optional).

Upholstery for armrest panels is available in five materials, synthetic leather, plush (optional), patterned fabric (optional), hygiene fabric (optional) and genuine leather (optional). Real leather is particularly recommended for allergy sufferers. For more information about upholstery, covers and available colours, please visit our website www.mercado.se. For an overview of available upholstery and covers, read the document 'Seat systems'.

ErgoMedic

The ErgoMedic armrest panel is curved at the back to keep the elbow stable. At the front, the armrest panel is shaped to give a good grip when getting up and transferring, see Figure 5.29. The armrest panel is available in lengths from 250 mm to 400 mm.

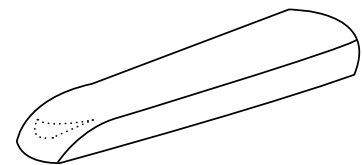

Figure 5.29. ErgoMedic armrest panel.

Mobile

The Mobile armrest panel has slightly thicker foam and is slightly wider than the ErgoMedic armrest panel. It is also wider at the front, which provides more stable support when the user sits down or gets up, see Figure 5.30. The armrest panel is available in lengths from 250 mm to 400 mm.

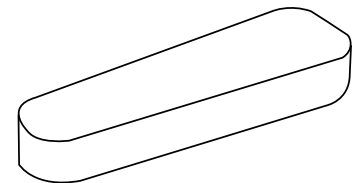

Figure 5.30. Mobile armrest panel.

ErgoMedic Plus

The ErgoMedic Plus armrest panel is shaped so that the arms are supported from the sides, which means that the upper body is more relieved. The armrest plate is ergonomically shaped at the front to relieve the wrist and wrist in a resting position, while the user receives good support when sitting down and getting up, see Figure 5.31. The armrest panel also works well as a Hemiplegia armrest. The armrest panel is available in lengths from 300 mm to 420 mm.

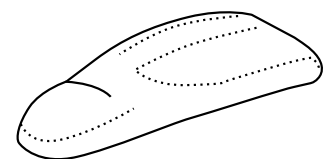

Figure 5.31. ErgoMedic Plus armrest panel.

Hemiplegia

The Hemiplegia armrest panel is designed for the Hemiplegia armrest (optional) allowing the armrest to be rotated in front of the body. The armrest panel has edges on the outside and inside and is extra long to support the hand, see Figure 5.32. The armrest panel is available in length 450 mm.

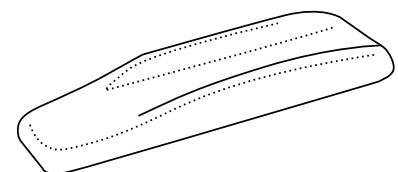

Figure 5.32. Hemiplegia armrest panel.

Extra Soft

The Extra Soft armrest panel is a slightly wider armrest panel with a very soft and flexible foam. The armrest panel is designed for pain-sensitive users, but also works for users who sit for long periods of time, see Figure 5.33. The armrest panel is available in lengths from 250 mm to 350 mm.

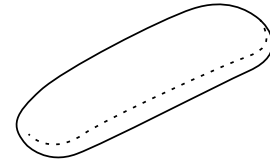

Figure 5.33. Extra Soft armrest panel.

5.12. Armrest mechanism

The armrest mechanism is available in three versions, PLUS armrests, folding armrests (optional) and Hemiplegia armrest (optional). The Hemiplegia armrest allows the armrest to be rotated in front of the body. This is for users who have little or no function in the arm or hand.

When using the seat tilt, the armrests can be fitted so that they either move with the seat when angled or stay in their original position, see Figure 5.37. Armrests that move with the seat are standard for the electric seat tilt. Armrests that stay in their original position are standard for the manual seat tilt. The Hemiplegia armrest must always be fitted so that it moves with the angle of seat tilt.

PLUS armrest

The PLUS armrest is adjustable in height (A) and width (B), see Figure 5.34.

Height setting:

1. Height adjustment. Loosen the knob and adjust to the desired height.
2. Tighten the knob.

PLEASE NOTE! Tighten the knob fully on the PLUS armrest.

Depth setting:

1. Loosen the knob and adjust to the desired width.
2. Tighten the knob securely.

PLEASE NOTE! Width adjustment of the armrests should be adjusted by the prescriber, as it may adversely affect the seating ergonomics if this setting is not correct. This particularly applies if the device has side supports fitted.

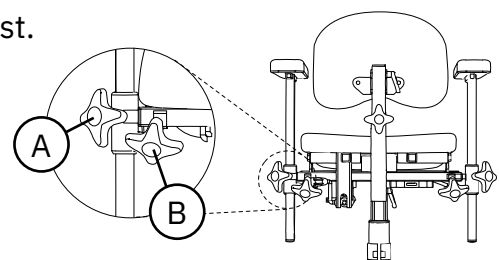

Figure 5.34. PLUS armrest.

Foldable armrests

Folding armrests are adjustable in height (A), width (B) and can be folded backwards (C), see Figure 5.35.

For height and width adjustment, see PLUS armrest.

Folding the armrests:

1. Pull out the knob, and if necessary turn it so that it locks in the extended position.
2. Hold the armrest and rotate the armrest backwards to fold it.
3. Rotate the armrest forwards to fold it back.
4. Make sure the knob clicks into the locked position. If the knob does not click in position, rotate the knob until it clicks firmly.

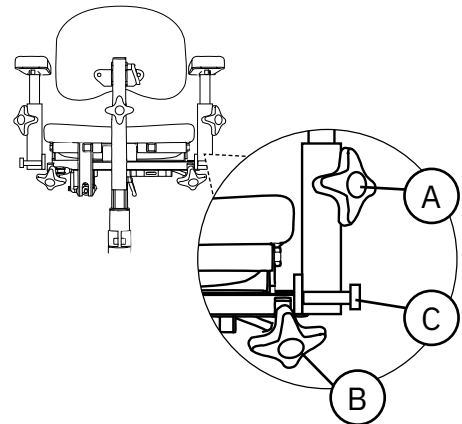

Figure 5.35. Foldable armrests.

Hemiplegia armrest

The Hemiplegi armrest is adjustable in height (A), width (B) and rotation (C), see Figure 5.36.

For height and width adjustment, see PLUS armrest.

Armrest rotation:

1. Loosen the knob and adjust to the desired position.
2. Tighten the knob.

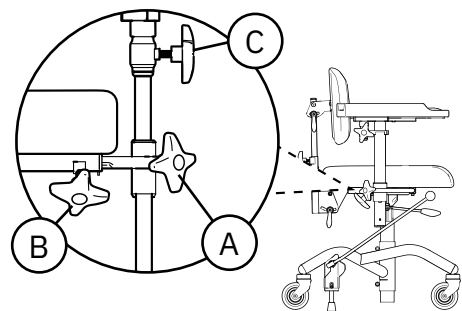

Figure 5.36. Hemiplegia armrest.

Using the seat tilt

Armrests can be fitted so that they move with the angle of the seat (A) or that they stay in their original position (B).

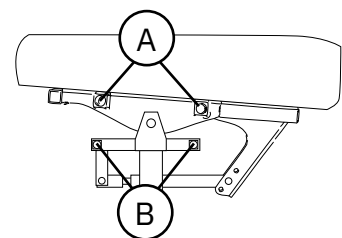

Figure 5.37. Armrest placement when using seat tilt.

5.13. Base

The REAL 9000, 9100, 9700 and 9800 PLUS adult models are equipped with the 9000 PLUS 48 base. The base is front braked² and standard for configurations with seat widths 400–480 mm. The REAL 9300 and 9400 PLUS child models are equipped with the 9000 PLUS 43 base. The base is rear braked² and can be used on configurations with seat widths up to 400 mm. The 9000 PLUS 48 stand is also available in a rear braked version (optional). The bases can also be equipped with a base extender (optional) and folding foot ring (optional) available in 1/4 or 1/8 version. A 1/8 foot ring is available in both a right and left model.

For increased braking performance or increased brake stability, the device can be equipped with a base with four brake legs, 9000 48 base, 4-braked (optional).

The EVI model has a separate base with high-low function, brake and built-in height adjustment and seat tilt.

9000 PLUS 48 base

The base has two brake legs and brakes forwards, see Figure 5.38.

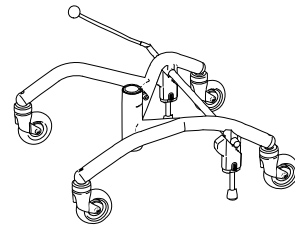

Figure 5.38. 9000 PLUS 48 base.

9000 PLUS 43 base

The base has two brake legs and brakes backwards, see Figure 5.39.

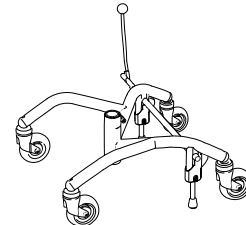

Figure 5.39. 9000 PLUS 43 base.

Base extender

Base extenders can be fitted forwards or backwards, see Figure 5.40.

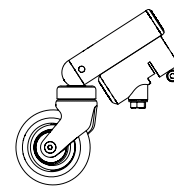

Figure 5.40. Base extender.

² The forward and backward brakes respectively describe the position of the brake lever in the brake position. The forward brake is normally used by the user themselves. The backward brake is normally used by an assistant.

Folding foot ring 1/4

The folding foot ring 1/4 is located at the front of the base and folds up into one piece, see Figure 5.41.

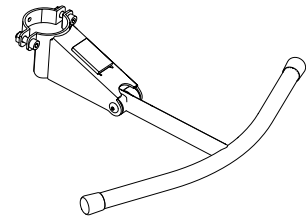

Figure 5.41. Foot ring 1/4.

Folding foot ring 1/8

The folding foot ring 1/8 is located at the front of the base and folds up into one piece, see Figure 5.42.

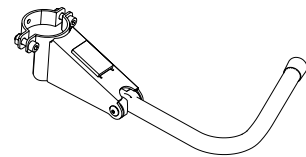

Figure 5.42. Foot ring 1/8 left model.

Four-braked base

The 9000 48 base has four brake legs and brakes backwards, see Figure 5.43.

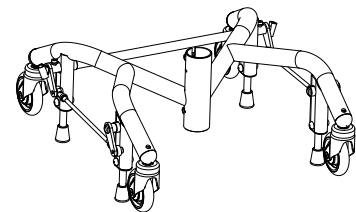

Figure 5.43. Four-braked base.

Base with high-low function

The base has individual brakes on each castor, as well as built-in adjustment for seat height and tilt, see Figure 5.44. Seat height (A) and seat tilt (B) are adjusted with pedals at the rear edge of the base, see Figure 5.45. The pedals also have an integrated locking function, see Figure 5.46.

Seat height adjustment:

1. Hold down the left pedal and pull the seat up or down to the desired height.
2. Release the pedal to lock the position.

Activation and deactivation of brake:

1. Press the pedal on the link wheel down to brake. Each castor is braked separately.
2. Press the pedal on the link wheel up to release the brake.

Seat tilt adjustment:

1. Hold down the right pedal and tilt the seat to the desired angle.
2. Release the pedal to lock the position.

Activation and deactivation of pedal locking function:

1. Turn the foot pedal control a quarter of a turn and release so that the control is pulled to the locked position.
2. Pull out the switch and turn a quarter turn to put the control in the unlocked position.

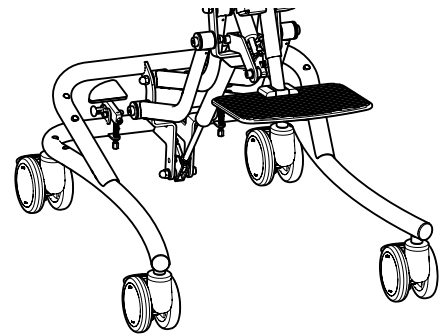

Figure 5.44. Base with high-low function.

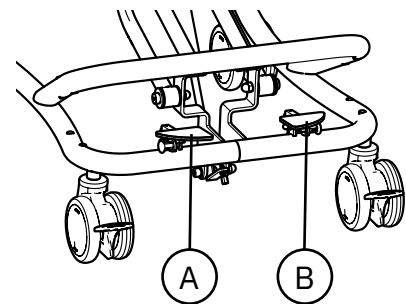

Figure 5.45. Foot pedals for adjusting seat height and tilt.

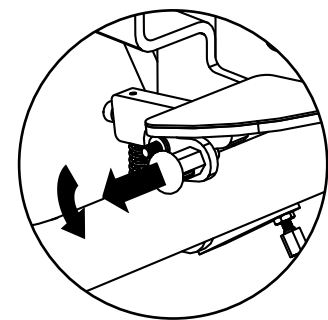

Figure 5.46. Locking function for pedals.

5.14. Manual brake

Manual brake is available in two versions, brake lever (350 mm as standard) and foot brake (optional). The brake lever is available in two models, brake lever with knob and brake lever with loop. The brake lever with knob is available in three lengths: 250 mm (optional), 350 mm (standard) and 450 mm (optional). The brake lever with loop (optional) is available in length 530 mm. This is used to reduce the range of motion needed for the arm when braking. The brake is also available as an electrical function, see 5.3. Electrical functions.

Brake lever

The brake lever can be placed on the right (A) or left (B) side of the base, see Figure 5.47.

Activation and deactivation:

1. Pull the brake lever to the locking position to brake.
2. Pull the brake lever in the opposite direction to disengage.

Setting the brake lever bracket:

Brake lever brackets are located on the outside of the base at the rear wheels on the right and left sides. In order to brake even when the armrest is adjusted out in width, the brake lever brackets can be adjusted out, see Figure 5.48.

1. Loosen the screw on the brake lever bracket with a 6 mm Allen key. Gently pull out the bracket.
2. Attach the screw to the next hole and tighten the screw tightly with the Allen key.

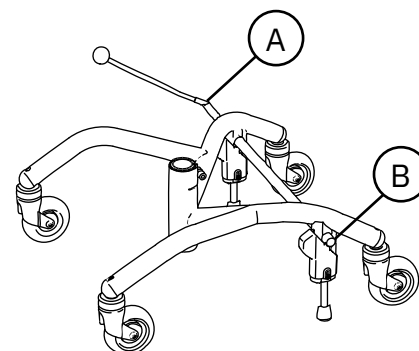

Figure 5.47. Brake lever.

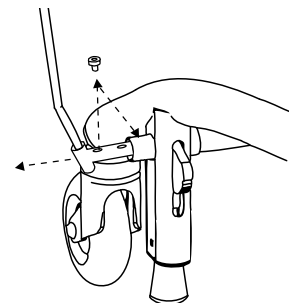

Figure 5.48. Setting the brake lever bracket.

Foot brake

If the device is equipped with a foot brake, this is located on the brake shaft of the base, see Figure 5.49. The foot brake is normally used by an assistant.

Activation and deactivation:

1. Push down to the locking position to brake.
2. Press upwards on the underside of the pedal to disengage the brake.

PLEASE NOTE! The brake must be locked in position when getting in and out of the chair.

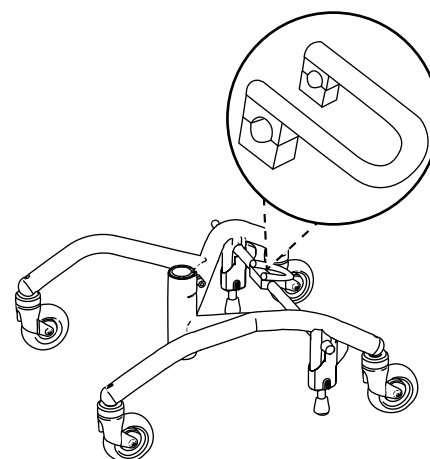

Figure 5.49. Foot brake.

5.15. Individual adaptation

The device must not be equipped with any accessories or components other than those approved by Mercado Medic. To maintain the CE marking, no individual modifications or changes may be carried out without Mercado Medic's approval. Modifications may be made only by personnel who have completed Mercado Medic's training for servicing and reconditioning.

Mercado Medic's devices are modular and can be customised with various accessories. The components available, as well as how to use them and what they are used for, can be found in the document 'Accessories' on www.mercado.se/en/mercado-document. All accessories must be mounted and fixed so that they maintain their setting and that there is no possibility for small parts to come loose. All cables must be secured with cable ties to the device's structure to minimise the risk of strangulation.

In addition to its own range, Mercado Medic has combination agreements with several companies. A list of the current companies and components can be found under the Combination Agreements section of www.mercado.se/en/mercado-document. These items may be assembled while maintaining the CE marking.

If an item that is not on the list of applicable combination agreements is fitted, the responsible organisation must carry out a risk analysis and take over device responsibility from Mercado Medic regarding the specific device. If a third-party item is frequently used on the device, you can contact Mercado Medic with a request for a combination agreement between the supplier of the item in question and Mercado

Medic. The item to be evaluated is sent to Mercado Medic, which evaluates whether combination agreements are up to date. After that, a risk analysis is carried out on the combination as desired. When a risk analysis is carried out, the customer receives a written statement and a new combination agreement is drawn up. The combination agreement is presented on the website www.mercado.se/en/mercado-document.

If the following guidelines are met when individually adapting authorised personnel of an organisation other than Mercado Medic, then Mercado Medic retains device responsibility for the device.

- Padded parts such as seats, backrests, armrests, side supports, trunk supports and neck supports can be adapted so long as they do not exceed the existing external dimensions of the device.
- The user's centre of gravity must be maintained over the lifting mechanism.
- Padded parts must be able to withstand the applicable flammability requirements and other environmental requirements. If a third-party seat cushion is used, the device must be fitted with a seat mat in anti-slip material of an equivalent size in order to ensure the safety of the device.
- Surfaces that are loaded with significant vertical forces must not fall outside the area (base) that is formed by the centre points of the castors.

devices that have undergone changes outside of the above guidelines must be verified by Mercado Medic in order for Mercado Medic to continue to retain device liability.

For devices specially adapted by healthcare services, outside Mercado Medic's directive, device liability passes to the healthcare services until the device has been restored to original condition or removed from the market. Mercado Medic will then re-assume device liability in accordance with the CE marking Regulation on Medical Devices (EU) 2017/745, MDR.

For questions regarding customisation, please contact the device Manager at Mercado Medic using the contact details of the head office under Section 1.1. Contact details.

6. Important safety information

Our website www.mercado.se has information about any safety notices to the market or recalls of devices and accessories.

6.1. Standards met and classification

Mercado Medic's work chairs are CE marked in accordance with the Regulation on Medical Devices (EU) 2017/745, MDR, and the Medical devices Agency's Code of Statutes for Medical Devices LVFS 2003:11. The devices are medical devices as defined in Article 2 of the MDR. The devices are classified as Class 1 non-invasive medical devices in accordance with Regulation 1. The active property of the device variants with electrical functions is not considered to affect the classification.

The devices are tested and approved according to the following standards:

- EN 12182:2012
- IEC 60601-1:2005 + A1:2012
- EN 60601-1-2:2015
- EN 60601-1-11:2015 + A1:2020
- EN 1335-1:2000
- EN 1335-2:2009
- EN 1335-3:2009

The following standards have also been used in the development of the devices:

- EN 1041:2008 + A1:2013
- EN ISO 14971:2020

All textiles on the devices have been tested and approved according to the following fire protection standards:

- EN 1021-1:2014 (ignition source: lit cigarette)
- EN 1021-2:2014 (ignition source: gas flame equivalent to a burning match)

Only the underside of the seat and armrests do not have fire protection as they are wooden. All other surfaces are made of metal or clad in fire protection-rated textiles. Armrests, seats, backrests, etc. have been developed and designed to be free from toxic substances and allergens.

Models with electrical functions are classified according to IEC 60601-1:2005 as a medical device with applied part (Applied Part as defined in standard) of type B associated protection class II with internal power source.

Models with electrical functions meet protection class IP21. The first digit (2) covers contact protection for fingers, etc., preventing access to hazardous parts with fingers or similar. The second digit (1) means vertical drip protection, and so the device can therefore withstand light showers from above.

6.2. Warnings



Warning! As a user, you should contact your prescriber, technical aids centre or distributor if the device shows reduced or altered performance. A device showing a loss of or change in performance must immediately be taken out of use in order to avoid an accident. The device must not be used again until an authorised technician has examined the device.



Warning! To maintain safety, the device should only be used by the person and purpose for which it is intended. The device is set up for a single user. Changing settings may affect the user's seating position, which may result in damage or injury.



Warning! You are not permitted to modify the device yourself. If you would like individual customisation, contact your prescriber or distributor. If the device is modified, the CE marking no longer applies and Mercado Medic may no longer have full device liability. Modifications may affect the safety of the device and lead to accidents.



Warning! The device may be equipped with long cables or wires that cannot be secured in order for the device to function properly. Cables and wires can pose strangulation risks to small children, for example. Do not leave the device unattended with small children nearby.



Warning! The device is equipped with small parts such as screws that can come loose. Small parts that have come loose can pose choking hazards for children and pets.



Warning! Metal surfaces may become very hot if they are exposed to direct sunlight. Skin contact with hot surfaces can lead to burns. Avoid exposing metal surfaces to direct sunlight.



Warning! Always ensure that the device's brake is applied when sitting down and getting up. If the device is not braked, it risks rolling away when you get up or sit down, which can lead to fall injuries.



Warning! Repairs and other technical measures may only be carried out by personnel authorised by Mercado Medic. If this is not followed, the CE marking no longer applies and Mercado Medic may no longer have full device liability.



Warning! The device must not be loaded with loads higher than the maximum user weight. At higher loads, there is a risk that the life of the device will be shortened and components may break. If the device has been subjected to higher loads than intended, authorised personnel should carry out an overall assessment, see 6.3. Expected service life, to ensure that it remains safe to use the device.



Warning! Electric models have a lifting mechanism that can lift the user so high that it can pose a risk. If the user cannot get out of the device from its highest position, then the seat height should never be higher than the position at which the patient's feet touch the ground. The only exception to this is cases where the user can summon help via a home-help alarm or telephone.



Warning! Only tested and approved batteries and chargers from Mercado Medic may be used with models with electrical functions. If using a different charger or different batteries to those which are provided alongside the device by Mercado Medic AB, the CE marking and Mercado Medic AB's device liability will cease to be valid for any cases regarding the battery, charging or other electronics of the device.



Warning! The device must not be equipped with any accessories or components other than those approved by Mercado Medic. To maintain the CE marking, no individual modifications or changes may be carried out without Mercado Medic's approval. If unapproved components are intended to be used, see section 5.15. Individual adaptation.



Warning! Do not plug any electrical accessory, other than those customised by Mercado Medic, into the control system's contacts. Non-adapted components are at risk of breaking and in turn injuring the user. If unapproved components are intended to be used, see section 5.15. Individual adaptation.



Warning! Installation, connection or dismantling is not risk-free. If components are handled incorrectly, for example, crushing damage may occur. This type of work may therefore only be carried out by a Mercado Medic authorised technician.



Warning! All parts of the device must be installed and fixed so that there is no risk of small parts coming loose. All cables must be secured with cable ties to the device's structure to minimise the risk of strangulation.

6.3. Expected service life

The expected service life of the device is ten years when used in accordance with these instructions for use. The expected service life of the device is calculated from the date of manufacture of the device. The date of manufacture of the device can be found on one of the silver labels on the device's base and is in the format YYYY-MM (year and month), see Figure 6.1. The label also includes serial numbers and an identifier for the device model (UDI-DI).

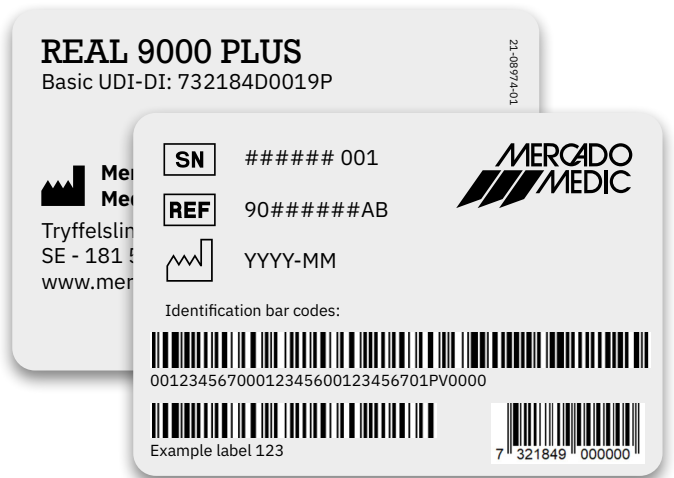

Figure 6.1. Serial number, UDI-DI and date of manufacture on the label.

PLEASE NOTE! If the serial number label and the date of manufacture are damaged or destroyed, please contact your prescriber or distributor in the first place for assistance in identifying the device, see 1.1. Contact details. Once the order number or serial number is identified, contact Mercado Medic for a replacement label.

The expected service life of accessories supplied with a Mercado Medic device is 10 years unless otherwise stated in the accompanying documentation.

The expected service life of the device battery is 5 years when the device is charged in accordance with these instructions for use, see 2.3. Charging.

In markets outside Sweden and Norway where a distributor has sold the device directly to the user (where applicable), and therefore there is no responsible prescriber, periodic maintenance must be carried out at least every other year throughout and after the device's entire expected service life. Maintenance should be carried out according to these instructions for use, see page 8. Servicing and reconditioning, in addition to the overall assessment below.

After the expected service life, Mercado Medic cannot guarantee the suitability and safety of the device, as Mercado Medic has no control over how the device has been used and its wear and tear. After the expected service life, Mercado Medic AB cannot guarantee the provision of spare parts.

Overall assessment

After the expected service life, it is important to make an overall assessment of the device before continuing to use it. The overall assessment of the device shall be carried out by authorised personnel of the

healthcare organisation if the device has been prescribed and should at least take into account:

- how the device has been used,
- what condition the device and its components are in,
- whether the device has been reconditioned and serviced,
- when reconditioning and servicing have been carried out,
- what has been remedied on the above occasions,
- and the reason for the above remedial measures.

After the expected service life, periodic maintenance at intervals of a maximum of 2 years shall be carried out according to these instructions for use, see 8. Servicing and reconditioning, in addition to the overall assessment below.

6.4. Reporting of adverse events and incidents

As a manufacturer of medical devices in the EU, Mercado Medic is obliged to have a system to monitor how our devices work in practical use.

Before our devices are CE-marked and placed on the market, we have taken into account the risks that may be present with them and taken measures to reduce the risks as far as possible. Nevertheless, accidents and incidents can occur when the devices are used. If this happens, it is important that this is reported to both Mercado Medic and the national relevant authority. Use contact details in these instructions for use for reporting, see 1.1. Contact details. Feel free to use email to enable faster handling.

7. Technical information

This section describes the dimensions and performance of the device, as well as symbols that appear on the device.



Warning! Repairs and other technical measures may only be carried out by personnel authorised by Mercado Medic. If this is not followed, the CE marking no longer applies and Mercado Medic may no longer have full device liability.

User weight

Model	Max
REAL 9000 PLUS and REAL 9700 PLUS	150 kg
REAL 9100 PLUS and REAL 9800 PLUS	150 kg
REAL 9300 PLUS and REAL 9400 PLUS	75 kg
EVI	50 kg



Warning! The device must not be loaded with loads higher than the maximum user weight. At higher loads, there is a risk that the life of the device will be shortened and components may break. If the device has been subjected to higher loads than intended, authorised personnel should carry out an overall assessment, see 6.3 Expected service life, to ensure that it remains safe to use the device.

Device characteristics for all models

	REAL 9000 PLUS REAL 9100 PLUS REAL 9700 PLUS REAL 9800 PLUS	REAL 9300 PLUS REAL 9400 PLUS	EVI
Width	480 mm ¹	430 mm ¹	440 mm ¹
Length	550 mm	550 mm	570 mm
Total height	600–1030 mm ²	600–1030 mm ²	690–1070 mm ³
Seat height	320–750 mm ⁴	320–750 mm ⁴	235–615 mm
Seat width	400–480 mm	290–400 mm	290–330 mm
Seat depth	390–530 mm	320–480 mm	320–350 mm
Seat tilt ⁵	0, -15°/+8°, -8°/+15°, 0°/+23°, -15°/+15°	0, -15°/+8°, -8°/+15°, 0°/+23°, -15°/+15°	-0/+34°
Backrest height	200–430 mm	200–430 mm	200–340 mm
Backrest width	350–460 mm	230–360 mm	230–300 mm
Back recliner ⁵	-15/+30°, -3/+40°, -15/+45°, -23/+28°	-15/+30°, -3/+40°, -15/+45°, -23/+28°	-15/+45°
Castors	Ø100 mm	Ø100 mm	Ø100 mm
Weight	20–38 kg	20–38 kg	Approx. 25 kg
Maximum slope of surface in braked position ⁶	5°	5°	2°

Device characteristics for all electric models

Battery	805320 Battery pack 2.6Ah 24V f RCB10+L
Battery type	Sealed valve-controlled lead acid battery
Voltage, battery pack	24V (2 x series coupled 12V batteries)
Charger	805289 Battery charger 9000 30V for work chairs 24V 1.5G (UK)

On a full charge with a high electrical lifting mechanism, you can raise the chair fully up/down a maximum of 180 times with a load of 80 kg, or up to 135 times with a load of 150 kg.

The electrical functions, except raising and lowering, may be used for max. 10% of the time (max. 2 mins/20 mins). The electronics measure activity and shut down the electrical functions if this limit is exceeded. When the total usage time in the last 20 minutes is below 2 minutes, the features are automatically activated again.

1 Depending on the seat width and the adjustment of the armrests, the device may become wider.

2 Total height with ErgoMedic backrest 380 x 260 mm.

3 Total height with ErgoMedic backrest 250 x 340 mm.

4 These seat heights are achieved with different lifting mechanisms.

5 Negative angle (-) refers to forward tilt and positive angle (+) refers to backward tilt.

6 Applicable in all directions.

7.1. Symbols

The following symbols are used on the device controls, markings or in these instructions for use. For an overview of the positioning of symbols, see Figure 7.1-7.5.

No. Manual controls

1		Seat height up/down
2		Seat tilt forwards/backwards
3		Back recliner forwards/backwards

No. Electric controls and control box

4		Battery level indication
5		Warning light
6		Seat height up/down
7		Seat tilt forwards/backwards
8		Back recliner forwards/backwards
9		Brake activation/deactivation
10		Charging socket
11		Input for control
12		Connection for electric lifting mechanism
13		Seat tilt connection

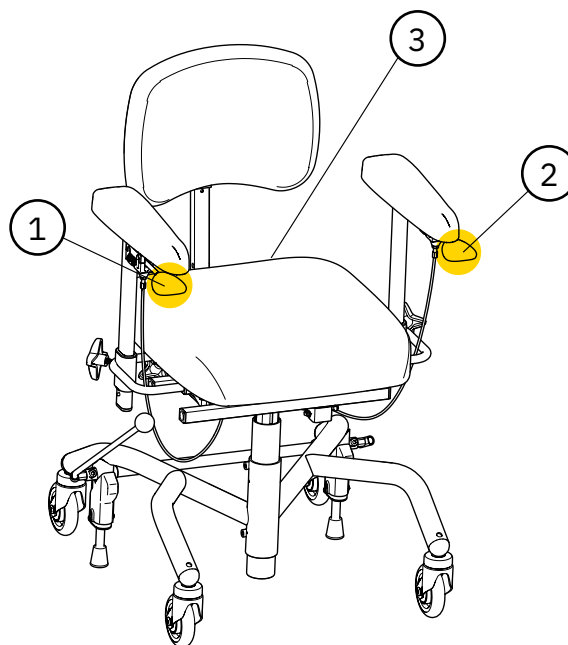

Figure 7.1. Overview of symbols on controls on manual model.

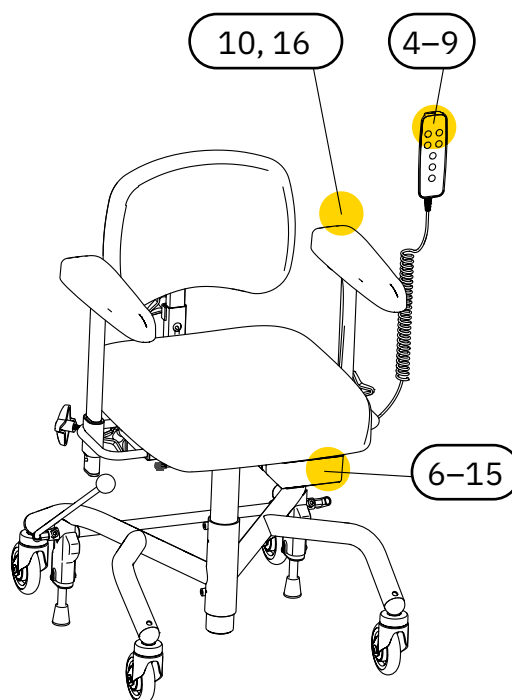















Figure 7.2. Overview of symbols on controls on electric model.

No. Electric controls and control box

14		Connection for back recliner
15		Brake connection
16		Read the instructions for use before use

No. Labelling and instructions for use

17		Warning
18		Warning, crushing risk
19		Not to be ironed
20		Do not use dry cleaning fluid stronger than perchlorine
21		Do not use chlorine bleach
22		Do not tumble dry
23		Machine wash 60°C
24		Protect from moisture
25		Handle with care
26		This side up
27		Permitted temperature

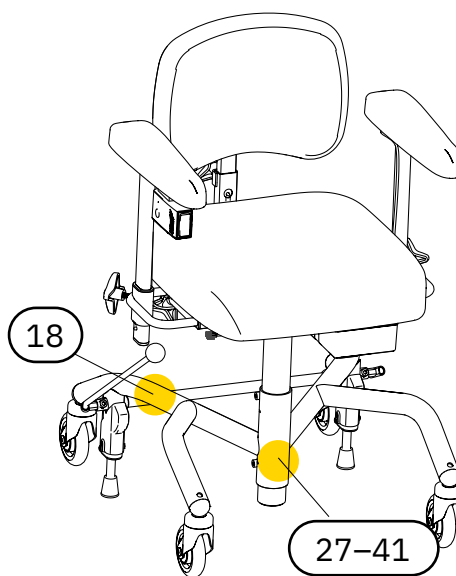

Figure 7.3. Overview of symbols on marking.



Figure 7.4. Overview of symbols on laundry care. Symbol 19–23.

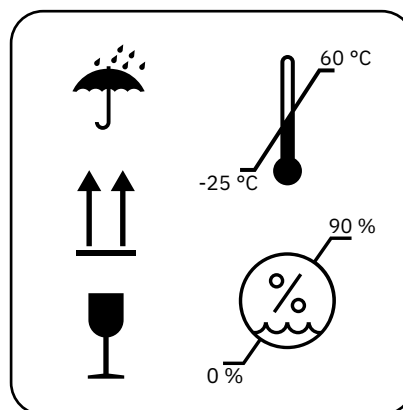















Figure 7.5. Overview of symbols on packaging. Symbol 24–28.

No. Labelling and instructions for use

28		Permitted relative humidity
29		Permitted altitude
30		For indoor use only
31		Maximum user weight
32		Date of manufacture
33		Manufacturer
34		Medical device
35		Serial number
36		CE mark showing the device's conformity with the European regulatory framework
37		Device classified as Type B applied part according to IEC 60601-1:2005
38		Electrical components must be disposed of at a special collection point
39		The device is part of a recycling system
40		Component weight exceeds 10 kg
41		Operating cycle

8. Servicing & reconditioning

This section describes the inspection and troubleshooting of the device, information about battery replacement and instructions for reconditioning the device. The troubleshooting guide is aimed at all users of the device, and the section is otherwise aimed at those who handle these parts of the device lifecycle professionally.

PLEASE NOTE! The user must not sit in the device while it is being reconditioned or serviced or during maintenance.

Inspection during service

A thorough visual inspection must be performed of the device's main components in order to guarantee the patient's safety. The main components of the device include base, brake, lifting mechanism, seat frame, back recliner and armrest mechanism. The inspection must include welds, lockable functions and settings.

When checking the PLUS base, always inspect the weld between the base's front and rear legs. Any indication of cracks in the material or paint in this area should be regarded as reason to replace the base, or the device. Ensure good lighting and preferably use a magnifying glass, as small cracks can be difficult to detect on black lacquered bases.

In case of reduced braking action, check both the stability of the base and the condition of the brake rubber. If the device is not resting on all four wheels in the unbraked position, the device must be withdrawn from service immediately. Check the balance of the base in several locations and in several directions to exclude any influence from the floor.



Warning! Repairs and other technical measures may only be carried out by personnel authorised by Mercado Medic. If this is not followed, the CE marking no longer applies and Mercado Medic may no longer have full device liability.



Warning! As a user, you should contact your prescriber, technical aids centre or distributor if the device shows reduced or altered performance. A device showing a loss of or change in performance must immediately be taken out of use in order to avoid an accident. The device must not be used again until an authorised technician has examined the device.

8.1. Troubleshooting guide

If none of the following actions address the problem that has occurred, service may be required. Please contact your dealer or get in touch with Mercado Medic, see 1.1. Contact details.

Troubleshooting for electrical functions

Symptom	Cause	Action
The control box emits an audible signal.	The device has a low or critical battery level.	Charge the device, see 2.3. Charging.
The warning light is flashing on the controller.	The work cycle, that is, the maximum time an electrical function can be used before it needs to rest, is approaching its limit. See 7. Technical information for details.	Allow the device to recover; otherwise the device will shut down the current electrical function until the device has recovered.
The electrical functions do not work. The warning light flashes when a button is pressed, if the controller is in use.	The work cycle has been exceeded, see 7. Technical information. If the limit is exceeded, all electrical functions are switched off, except for electrical height adjustment. The features cannot be used again until the system has recovered.	The device will start working again once the system has recovered. This takes up to 20 minutes.
The warning light is flashing on the hand-held controller.	The button lock has been activated.	To enable or disable the button lock for a function, press and hold both of the directional buttons of the relevant function for at least three seconds. Each function has a separate button lock.
The warning light is flashing on the hand-held controller.	An internal error has occurred.	The system will be reset automatically after 10 seconds. If the error has been resolved, then all channels will be unlocked and the warning light will be switched off.
The electrical functions do not work. No hand-held controller is used, or the controller does not display a signal on the battery level indicator lights or warning.	The battery needs to be charged or activated. If the device has been unused for 7 days or more, the battery will be automatically disconnected to maximise service life.	Charge or activate the battery by connecting the charger. It is recommended to always charge fully when doing this. For activation only, it is enough that the charger is connected for about 5 seconds.

Symptom	Cause	Action
The electrical functions do not work. The indicator shows a low battery level if the controller is in use.	The internal batteries of the device are discharged or defective.	Charge the device, see 2.3. Charging. If charging does not fix the problem, a replacement battery is needed, see 8.2. Battery replacement.
Electrical functions do not work if a button on the wireless remote control is pressed.	The batteries in the wireless remote control are empty or defective.	Replace the batteries in the wireless remote control, see 8.2. Battery replacement.
The electrical functions do not work.	Defective actuator.	If the above measures have not resolved the problem, this may be because the actuator is defective and needs to be replaced.

Troubleshooting mechanical components

Symptom	Cause	Action
The seat slips in the direction of rotation.	Gap in the lifting mechanism.	Replace the lifting mechanism.
Noise in the electric lifting mechanism.	Worn bearings.	Replace the electric lifting mechanism.
Noise in the castors.	Worn bearings.	Replace the castors.
The device does not move smoothly.	Accumulation of hair and debris in castors.	Clean the castors, see 3. Caring for the device. Alternatively, replace the castors.
The device does not move smoothly.	Worn bearings or uneven wheel track.	Replace the castors.
The device does not brake satisfactorily.	Accumulation of dirt and dust under brake feet.	Clean the underside of the brake feet, see 3. Caring for the device.
The device does not brake satisfactorily.	The rubber brake feet have solidified over time.	Replace the brake feet ¹
The device does not brake satisfactorily.	The base is warped and needs to be replaced.	Replace the base and report this event to Mercado Medic. See 1.1. Contact details.

¹ The brakes must be checked on a regular basis, see 6. Important safety information.

8.2. Battery replacement



Warning! Repairs and other technical measures may only be carried out by personnel authorised by Mercado Medic. If this is not followed, the CE marking no longer applies and Mercado Medic may no longer have full device liability.

The internal batteries of the device can be replaced. Both batteries in the battery pack must be replaced at the same time. For instructions, see installation instructions 'Battery replacement 24V1G'.

To replace batteries in remote control, see installation instructions 'Remote control IR 24V 1G'.

Bear in mind the following when handling batteries:

- Never short-circuit the battery.
- Do not subject the battery to strong shocks.
- Always discard of used batteries at recycling centres.

First aid

If the battery is defective and handling it results in direct contact with the contents of the battery, electrolytes (sulphuric acid), the following applies:

Incident	Action
Skin contact	Rinse with water. Clean with soap and water. Remove and wash affected clothes.
Inhalation of acid mist	Breathe fresh air. Seek medical attention immediately!
Contact with eyes	Wash eyes with running water for at least 15 minutes. Seek medical attention immediately!
When swallowed	Immediately drink plenty of water, do not induce vomiting. Seek medical attention immediately!

8.3. Reconditioning and periodic maintenance

The device does not require periodic maintenance in cases where it has a responsible prescriber in the healthcare sector. The prescriber and healthcare organisation are expected to follow up the prescription during the lifetime of the device according to the healthcare procedures. During this follow-up, it is important to question the performance of the device and any perceived changes. Where the device is sold by a distributor directly to the user and does not have the responsible prescriber, periodic maintenance at intervals of a maximum of 2 years must be carried out throughout and after the expected service life according to the following reconditioning instructions.

Reconditioning in these instructions for use does not refer to a full restoration or complete refurbishment in the sense referred to in the Medical Devices Regulation (EU) 2017/745, MDR, with a view to putting the device on the market again with a renewed expected service life. Reconditioning in these instructions for use aims instead at a more comprehensive review and service of the device, but where serial numbers are retained and expected service life remains unaffected. The purpose of this reconditioning may be, for example, to make the device suitable for prescribing to a new user.

Inspection during reconditioning

Reconditioning must include a thorough visual inspection of the device's main components in order to guarantee patient safety. The main components of the device include base, brake, lifting mechanism, seat frame, back recliner and U-bars for armrests. The inspection must include welds, lockable functions and settings.

When checking the PLUS base, always inspect the weld between the base's front and rear legs. Any indication of cracks in the material or paint in this area should be regarded as reason to replace the base, or the device. Ensure good lighting and preferably use a magnifying glass, as small cracks can be difficult to detect on black lacquered bases.

In case of reduced braking action, check both the stability of the base and the condition of the brake rubber. If the device is not resting on all four wheels in the unbraked position, the device must be withdrawn from service immediately. Check the balance of the base in several locations and in several directions to exclude any influence from the floor.

Replacement of components

On www.mercado.se there are various forms of substrate for changing components, such as exploded diagrams, assembly instructions, connection guides and digital item search. Installation instructions can also be used to disassemble the device's components. For accessories and spare parts please visit our webshop <https://shop.mercado.se/>.



Warning! Installation, connection or dismantling is not risk-free. If components are handled incorrectly, for example, crushing damage may occur. This type of work may therefore only be carried out by a Mercado Medic authorised technician.



Warning! All parts of the device must be installed and fixed so that there is no risk of small parts coming loose. All cables must be secured with cable ties to the device's structure to minimise the risk of strangulation.

Long-term storage of batteries

During longer periods of storage, the battery is automatically disconnected after seven days. The battery may also be forced into unplugged mode by plugging a 9V power supply (part number 804823) into the charging socket and waiting for at least 5 seconds before disconnecting the power supply. If the handheld controller is used, all of the indicator lights will flash when the battery is disconnected and the power supply can then be disconnected.

When the battery is disconnected, it must be charged every four months in order to

retain its functionality, see 2.3. Charging. If these charging instructions are followed, the battery will maintain sufficient capacity for 5 years.

To reconnect the battery to the system again, connect the battery charger to the charging outlet and wall socket. Wait at least five seconds before disconnecting the battery charger. The battery is now activated again and the system is ready for use. We recommend leaving the charger in place and fully charging the battery after the device has been stored with the battery in a disconnected state.

Reconditioning instructions

Do not use high pressure washers when cleaning the device. For instructions on everyday cleaning, see 3. Caring for the device.

The following points should be performed during reconditioning to ensure patient safety:

ID	Area	Reconditioning instructions
1 Cleaning		
1.1	Mechanisms	Clean mechanical parts (not the actuator) using a clean, damp cloth with mild detergent (pH 7-12), surface disinfectant or use a steam cleaner (max. 8 bar). PLEASE NOTE! Do not wash the device with water or other liquids and chemicals.
1.2	Electronics and cables	Remove dust with a dry cloth.
1.3	Operating controls	Wipe the control controls with a cloth lightly dampened with disinfectant. This is so as not to pass on any possible infection.
1.4	Actuator and lifting mechanism	Moving parts are lubricated and should therefore not be cleaned. For lifting mechanisms, see special instructions under sections 3 and 4.
1.5	Padded parts	Remove and discard all padded parts. Wash any covers according to the washing instructions.
1.6	Castors	Clear the castors of hair and dust.

ID	Area	Reconditioning instructions
2 Electrical components		
2.1	Electronics	Start by charging the device for at least 5 seconds to activate the electronics. Check the electronics and all electrical functions. Check for physical damage to the control box and any contact box.
2.2	Charger	Check that the charger is working and that the casing and cables are undamaged.
2.3	Controls	Make sure that the control buttons and controller are working and have no damage to the casing or cables.
2.4	Contacts	Check that cables and connectors are intact and properly secured. Check that there is no risk of crushing cables and connectors, and that all cables are fastened with cable ties.
2.5	Batteries	Check the batteries' voltage and that there is not too great a difference between the batteries' charge. A large difference in charging may indicate that a battery cell is defective. See installation instructions 'Battery replacement 24V1G'. Keep in mind that the life expectancy of the batteries is 5 years when maintained according to these instructions for use. This means that it may be time to replace them depending on when the reconditioning is complete and what remedial actions have been taken on the device in the past.
2.6	Electric seat tilt	Check that the actuator is not visibly damaged. Check the function of the actuator's moving parts. Check that all locking screws are tightened to avoid any play in the end position.
2.7	Electric back recliner	Check that the actuator is not visibly damaged. Check the function of the actuator's moving parts. Check that all locking screws are tightened to avoid any play in the end position.
2.8	Electric brake	Check that the actuator is not visibly damaged. Check the function of the actuator's moving parts. Check that all locking screws are tightened to avoid any play in the end position. Check that the attachments are intact and securely fixed to the base.

ID	Area	Reconditioning instructions
3 Electric lifting mechanism		
3.1	Noise	Listen for noise in the lifting mechanism. Replace the lifting mechanism in case of noise. Load the device and check that the lifting mechanism does not slip when starting from the bottom position. Defective lifting mechanisms can be sent to Mercado Medic for repair.
3.2	Rotation lock	Make sure that the lifting mechanism does not have any play when rotating or loading from side to side. Replace the lifting mechanism in case of play. Defective lifting mechanisms can be sent to Mercado Medic for repair.
3.3	Lifting columns	Raise the lifting mechanism to the highest position. Wipe the lifting column of dust and dirt with a dry cloth. Then lubricate the lifting column using a thin layer of Teflon or silicone-based grease.
3.4	Attachment	Check that the seat is facing straight ahead relative to the base. Check that the lifting mechanism attachments to the seat frame are correctly assembled and tightened. Replace screws that have damaged key handles or threads.
3.5	Cabling	Inspect cables for any signs of wear, pinching or crushing.
4 Gas spring-operated lifting mechanism		
4.1	Rotation lock	Make sure that the lifting mechanism does not have any play when rotating or loading from side to side. Replace the lifting mechanism in case of play.
4.2	Lifting columns	Raise the lifting mechanism to the highest position. Wipe the lifting column of dust and dirt with a dry cloth. Then lubricate the lifting column using a thin layer of Teflon or silicone-based grease.
4.3	Attachment	Check that the seat is facing straight ahead relative to the base. Check that the lifting mechanism attachments to the seat frame are correctly assembled and tightened. Replace screws that have damaged key handles or threads.
4.4	Lock ring	Check that the lock ring under the bottom is securely fastened.
4.5	Gas spring lever	Check that the gas spring locks properly and that the height does not slowly change under load. If the height slowly changes under load, adjust the wire nipple. Check and replace damaged wires and sheaths.

ID	Area	Reconditioning instructions
5 Base		
5.1	Welds	Check all welds carefully for signs of cracks, corrosion and movement. Ensure good lighting and preferably use a magnifying glass, as small cracks can be difficult to detect on black lacquered bases. Make sure the base is stable. Fill in any varnish damage with touch-up paint to avoid corrosion.
5.2	Bolted joints	Check and tighten all screw joints. Replace screws that have damaged key handles or threads.
6 Brakes		
6.1	Function	Replace the brake feet. Check that the brake is working properly.
6.2	Plastic plugs	Check that guide bushings and plastic plugs are properly secured. Replace worn or damaged parts.
6.3	Pinch protection	Check that any pinch protection is securely mounted. If there is no pinch protection on the brake legs, it is recommended that this be installed before the device is put back into service.
7 Castors		
7.1	Function	Check castors and jumpers for wear or play. Wear or play may indicate defective bearings. Check that the castors rotate well and the housings rotate. Replace worn or damaged parts.
7.2	Attachment	Check that the castors' screws are intact and tightened. Replace screws that have damaged key handles or threads.
8 Seat frame		
8.1	Mechanics	Carefully check all welded parts for cracks and paint damage. In particular, check around the mounting of actuators for the seat tilt and at the holes for mounting leg supports, as these areas are particularly subject to load. Ensure good lighting and preferably use a magnifying glass, as small cracks can be difficult to detect on black lacquered structures. Fill in any varnish damage with touch-up paint to avoid corrosion.
8.2	Bolted joints	Check and tighten all screw joints. Replace screws that have damaged key handles or threads.
8.3	Plastic plugs	Check that guide bushings and plastic plugs are properly secured. Replace worn or damaged parts.
8.4	Controls	Make sure that all knobs and handles on the seat frame are working and that they lock correctly.

ID	Area	Reconditioning instructions
8.5	Gas spring-controlled seat tilt	If the device is equipped with gas spring controlled seat tilt, check that the gas spring locks the seat tilt properly. If the seat tilt slowly changes under load, adjust the wire nipple. Check and replace damaged wires and sheaths. Check for oil leaks in the gas spring. Replace the gas spring in case of oil leakage.
8.6	Crank-controlled seat tilt	If the chair is equipped with a crank-controlled seat tilt, check that there is no play and that all screws are tightened.
8.7	Coxit mechanics	Make sure that the knobs for the flaps turn easily and are securely locked with the counter nut. If necessary, lubricate the threads with teflon grease or silicone-based lubricant.
9 Backrest mechanism		
9.1	Mechanics	Check and replace any worn parts, carefully inspect for cracks in welds as they may have been heavily loaded for a long time. Ensure good lighting and preferably use a magnifying glass, as small cracks can be difficult to detect on black lacquered structures. Check that the moving parts work properly.
9.2	Attachment	Make sure that all screws, knobs and handles are easy to move and lock properly. Check that the spring button clips are working flawlessly.
9.3	Plastic plugs	Check that guide bushings and plastic plugs are properly secured. Replace worn or damaged parts.
9.4	Gas spring lever	Check gas pressure and stability in the gas spring. Check that the gas spring locks properly and that the back does not slowly change angle under load. Check and replace damaged wires and sheaths. Check for oil leaks in the gas spring. Replace the gas spring in case of oil leakage.
10 Armrests		
10.1	U-bars	Carefully check the U-bars for cracks and paint damage. Check especially around welds and grooves for the locking, as these areas are particularly subject to load. Ensure good lighting and preferably use a magnifying glass, as small cracks can be difficult to detect on black lacquered structures. Fill in any varnish damage with touch-up paint to avoid corrosion.
10.2	Function	Check and replace any worn parts. Test that locking and function in moving parts are working properly. Check that knobs and screws are working and have no damage to threads or grip surfaces.

ID	Area	Reconditioning instructions
10.3	Plastic plugs	Check that guide bushings and plastic plugs are properly secured. Replace worn or damaged parts.
10.4	Armrest mechanics	Check all welds and that there is no damage to mechanical parts that may impair or weaken the structure. Ensure good lighting and preferably use a magnifying glass, as small cracks can be difficult to detect on black lacquered structures. Fill in any varnish damage with touch-up paint to avoid corrosion.
11 Accessories		
11.1	Restoration	Remove the accessories that should not be attached to the device in the basic version, see 5.2. Basic design.
11.2	Mechanics	Check all welds and that there is no damage to mechanical parts that may impair or weaken the structure. Ensure good lighting and preferably use a magnifying glass, as small cracks can be difficult to detect on black lacquered structures.
11.3	Function	Check and replace any worn parts. Check that the locking and function of moving parts works properly.
12 Final inspection		
12.1	Final inspection	Test all functions of the device. Check that all settings, electrical functions and brakes are working properly. Check that the castors are working properly and that all four wheels are in contact with the surface.
12.2	Battery sleep mode	If electrical models are to be stocked, the battery can be put into sleep mode with the intended 9V adapter, see 8.3. Reconditioning and periodic maintenance, Long-term storage of batteries.

9. Instructions for destruction

Devices permanently decommissioned must be dismantled and sorted in a correct and safe manner. The website www.mercado.se/en/mercado-document there are installation instructions that can also be used to dismantle the device's components. The components should then be discarded in the relevant manner, see 9.1. Recycling sorting.



Warning! Installation, connection or dismantling is not risk-free. If components are handled incorrectly, for example, crushing damage may occur. This type of work may therefore only be carried out by a Mercado Medic authorised technician.

9.1. Recycling

Instructions for recycling of components.

Metal:

- Armrest mechanism
- Backrest mechanism
- Neck support mechanism
- Leg support
- Base
- Seat frame
- Actuator
- Lifting mechanism
- Gas springs
- Other metal parts in devices sold by Mercado Medic

Electronics:

- Cabling
- Control box (batteries to be dismantled and recycled separately)
- Contact box
- Hand-held controller
- Control buttons

Lead battery:

- Batteries (discarded batteries should always be taken to environmental recycling centres)

Combustible:

- Seat
- Backrest
- Neck support
- Armrests
- Other padded parts sold by Mercado Medic

