



THE REAL-CHAIRS ARE CE-CERTIFIED
IN ACCORDANCE WITH THE MPA STATUTES
OF MEDICAL DEVICES LVFs 2003:11.

2014

ERGONOMIC SEAT SYSTEMS

for the REAL-chairs





FITTED ARTICLES

Mercado produces all upholstered furnishings inhouse. We can as well manufacture these in any special size, material, clothing, etc. (please see page 22).

ErgoMedic®

UPHOLSTERY FOR REAL 9000, 9000 PLUS, 6100, 6100 PLUS

With various backs, seats, castors, lifting columns and accessories, it is easy to put a functional and comfortable chair together. To further increase sitting comfort, Mercado Medic has collaborated with registered physiotherapist, Bengt Engström, to develop the ErgoMedic seat system for the REAL 9000. ErgoMedic consists of three interacting parts: Seat, Back and Armrest.

BACKREST

The ErgoMedic back rest and seat work together to provide the most comfortable, and effective sitting position. The shape and angle of the high back has been improved to create more space for the pelvis and its softer parts. The lower edge of the back panel now has a gentle 'U'-shape and is softer. This, combined with the shape of the seat, provides better sitting depth and a more comfortable position for the lower back and pelvis.

SEAT

For optimal sitting comfort, the ErgoMedic-seats have the right form and softness to ensure optimal stability and comfort, higher at the thigh than the buttocks. Its form distributes pressure evenly and effectively and prevents the user from sliding forward when the seat is angled. The back edge of the seat is set low to increase the sitting depth. This means that the seat bone nodules can move backwards when the users stretch out forwards. When the pelvis is positioned at the very back of the seat, and well supported by the backrest, the users legs are also stabilized.

COXIT SEAT

Mercado's Coxit seat has the same high ergonomic quality as the ErgoMedic seat. The Coxit seat is divided with individually adjustable flaps.

It is used primarily for the alleviation and rehabilitation of orthopaedic injuries to hips or thighs.

ARMREST

The armrest is an extremely important part of the ErgoMedic system, so we have also developed these to be more ergonomic and comfortable. The edges have been bevelled, both on the inside and the outside to minimize the pressure against the underarms during prolonged contact. The armrest panels are hollowed out at the back in order to stabilize the elbows. At the front they have been designed to provide a good grip when standing up and transferring pressure.

The armrests are covered with soft imitation leather that is more pleasant to the touch and is less slippery if the armrest becomes damp.

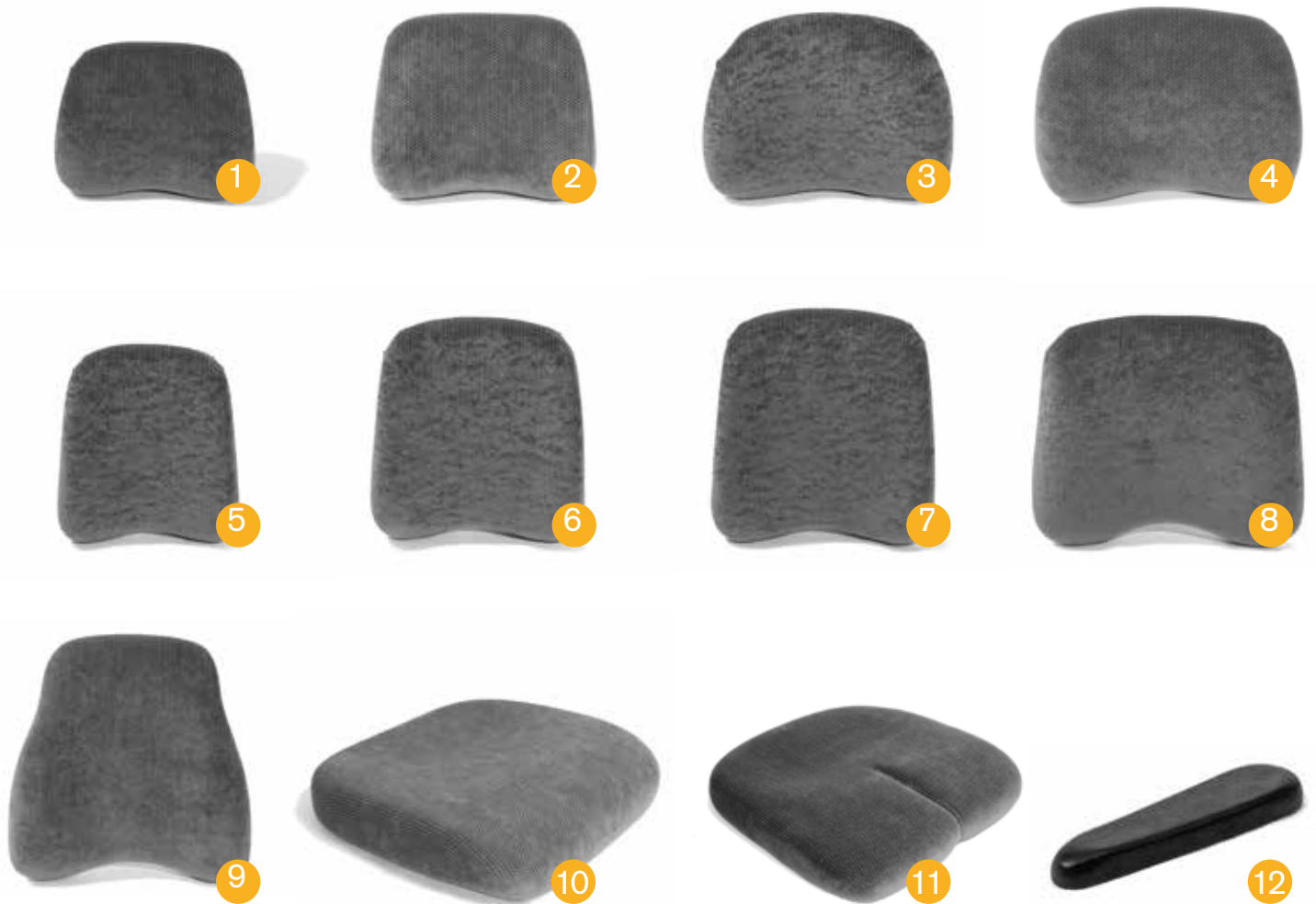

Backrest ErgoMedic, width x depth

1	Backrest low ErgoMedic 27x22 cm	BR107046
	Backrest low ErgoMedic 23x27 cm	BR105046
	Backrest low ErgoMedic 23x20 cm	BR108546
2	Backrest low ErgoMedic 30x26 cm	BR106546
3	Backrest low ErgoMedic 33x26 cm	BR106046
4	Backrest low ErgoMedic 38x26 cm	BR105546
5	Backrest high ErgoMedic 27x32 cm	BR104546
6	Backrest high ErgoMedic 30x34 cm	BR103546
7	Backrest high ErgoMedic 33x36 cm	BR102546
8	Backrest high ErgoMedic 40x34 cm	BR103046
9	Backrest high ErgoMedic 42x43 cm	BR101546
	Backrest high ErgoMedic 46x43 cm	BR101046

Seat ErgoMedic, width x depth

10	Seat ErgoMedic 29x32 cm	ST105546
10	Seat ErgoMedic 33x35 cm	ST105046
10	Seat ErgoMedic 36x39 cm	ST104546
10	Seat ErgoMedic 36x43 cm	ST104046
10	Seat ErgoMedic 40x39 cm	ST103546
10	Seat ErgoMedic 40x43 cm	ST103046
10	Seat ErgoMedic 40x48 cm	ST102546
10	Seat ErgoMedic 44x43 cm	ST102046
10	Seat ErgoMedic 44x48 cm	ST101546
10	Seat ErgoMedic 48x48 cm	ST101046

Article No.

Seat Coxit ErgoMedic, width x depth

11	Seat ErgoMedic Coxit 40x43 cm	ST133046
11	Seat ErgoMedic Coxit 40x48 cm	ST132546
11	Seat ErgoMedic Coxit 44x43 cm	ST132046
11	Seat ErgoMedic Coxit 44x48 cm	ST131546
11	Seat ErgoMedic Coxit 48x48 cm	ST131046

Article No.

Armrest ErgoMedic

12	Armrest ErgoMedic 25 cm	AR101038
12	Armrest ErgoMedic 30 cm	AR102038
12	Armrest ErgoMedic 35 cm	AR103038
12	Armrest ErgoMedic 40 cm	AR104038

EXPLANATION OF THE STRUCTURE OF THE ARTICLE NUMBER

Article No: **ST101546**
"ErgoMedic seat, plush grey 44x48 cm"

- Digits 1-2 = Type of upholstered article
- Digits 3-4 = Seat system
- Digits 5-6 = Size
- Digit 7 = Material
- Digit 8 = Colour

! Seats and backrests are also available in Slow Recovery.

FITTED ARTICLES

Mercado produces all upholstered furnishings inhouse. We can as well manufacture these in any special size, material, clothing, etc. (please see page 22).



ErgoMedic® PLUS

UPHOLSTERY FOR REAL 9000, 9000 PLUS, 6100, 6100 PLUS

BACKREST

The ErgoMedic Plus-back is available in several variants. The higher backrest provides more shape around the pelvis and thoracic spine, whereas the lower backrest has the same shape, but supports the pelvis and the lumbar spine.

The lower part of the high backrest is shaped so that you can sit with pelvic support even when tilted backwards. At the top in the centre, between the shoulder blades, a soft extra support has been integrated. This to enable the user to sit upright and stable against the backrest, whilst at the same time leaving enough room for free movement of the shoulders.

The high backrest is also available with extra side wedges. The low backrest has a similar shape to the high one, but is designed for supporting the pelvis and lumbar spine.

SEAT

The biggest requirement of the seat is to be stable and comfortable. ErgoMedic Plus-seats have the right form and softness to ensure optimal stability and comfort, higher under the thigh than the buttocks. Its form distributes pressure evenly and effectively, and prevents the user from sliding forward when the seat is angled.

When the user sits at the back of the seat, so that the pelvis is firmly placed against the lower parts of the back support, their legs are also stabilized. The higher rounded shape on either side of the thighs means that both the pelvis and the legs are stabilized.

ARMREST

The user should be able to switch between active and relaxed positions. The ErgoMedic Plus-armrests are shaped so the arms are supported from the sides, which means that the upper body is more relaxed. They are also raised beneath the wrists to provide extra relief. At the front, the armrest has a rounded convex shape, which makes it comfortable to rest the hand on, while providing a good grip when you want to get in or out of the chair.

NECKREST

The neckrest provides support primarily against the rear, lower part of the head. The lower part of the neck rest is built up with soft padding on each side, providing support for the lower skull and neck.

The upper part is flatter, which leaves room for the user to turn their head. The shape and properties of the neck rest means that the head is well stabilized, even when the user is sitting upright.



*8. ErgoMedic Plus Comfort-backrest is especially assembled for maximum comfort. It has an adjustable lumbar support (pump) which provides extra support in this region.

Backrest ErgoMedic PLUS, width x depth Article No.

1	Backrest ErgoMedic Plus 35x20 cm	BR208046
1	Backrest ErgoMedic Plus 40x20 cm	BR207546
2	Backrest ErgoMedic Plus 30x34 cm	BR203546
3	Backrest ErgoMedic Plus 35x43 cm	BR202046
4	Backrest ErgoMedic Plus 42x43 cm	BR201546
4	Backrest ErgoMedic Plus 46x43 cm	BR201046
5	Backrest EM Plus w wedge 30x34 cm	BR253546
6	Backrest EM Plus w wedge 35x43 cm	BR252046
6	Backrest EM Plus w wedge 42x43 cm	BR251546
6	Backrest EM Plus w wedge 46x43 cm	BR251046
7	Backrest EM Plus reinf wedge 35x43 cm	BR352046
7	Backrest EM Plus reinf wedge 42x43 cm	BR351546
7	Backrest EM Plus reinf wedge 46x43 cm	BR351046
8	Backrest EM Plus Comfort 35x43 cm	BR212046
8	Backrest EM Plus Comfort 42x43 cm	BR211546
8	Backrest EM Plus Comfort 46x43 cm	BR211046
8	Back EM Plus Comfort w wedge 35x43	BR262046
8	Back EM Plus Comfort w wedge 42x43	BR261546
8	Back EM Plus Comfort w wedge 46x43	BR261046
8	Back EM Plus Comfort reinf wedge 35x43	BR362046
8	Back EM Plus Comfort reinf wedge 42x43	BR361546
8	Back EM Plus Comfort reinf wedge 46x43	BR361046

Seat ErgoMedic PLUS, width x depth Article No.

9	Seat ErgoMedic Plus 29x32 cm	ST205546
9	Seat ErgoMedic Plus 33x35 cm	ST205046
9	Seat ErgoMedic Plus 36x39 cm	ST204546
9	Seat ErgoMedic Plus 36x43 cm	ST204046
9	Seat ErgoMedic Plus 40x39 cm	ST203546

Seat ErgoMedic PLUS, width x depth Article No.

9	Seat ErgoMedic Plus 40x43 cm	ST203046
9	Seat ErgoMedic Plus 40x48 cm	ST202546
9	Seat ErgoMedic Plus 44x43 cm	ST202046
9	Seat ErgoMedic Plus 44x48 cm	ST201546
9	Seat ErgoMedic Plus 48x48 cm	ST201046

Seat Coxit ErgoMedic PLUS, width x depth Article No.

10	Seat Coxit Int EM Plus 40x39 cm	ST233546
10	Seat Coxit Int EM Plus 40x43 cm	ST233046
10	Seat Coxit Int EM Plus 40x48 cm	ST232546
10	Seat Coxit Int EM Plus 44x43 cm	ST232046
10	Seat Coxit Int EM Plus 44x48 cm	ST231546
10	Seat Coxit Int EM Plus 48x48 cm	ST231046

Neckrest, width x height Article No.

11	Neckrest cushion EM Plus 30x23 cm	NS2046
12	Neckrest cushion EM Plus 30x8 cm	NS4046

Armrest Article No.

13	Armrest ErgoMedic Plus Right 42 cm	AR205138
13	Armrest ErgoMedic Plus Left 42 cm	AR205238
13	Armrest ErgoMedic Plus Right 30 cm	AR202138
13	Armrest ErgoMedic Plus Left 30 cm	AR202238

underlined article appears in the picture

! *Seats and backrests are also available in Slow Recovery.*

FITTED ARTICLES

Mercado produces all upholstered furnishings inhouse. We can as well manufacture these in any special size, material, clothing, etc. (please see page 22).



OTHER UPHOLSTERED PARTS

TRUNK SUPPORT

The trunk support is used to produce more upright, active sitting. Mercado has three types: curved and adjustable, straight, and curved trunk support.

NECK REST

The neckrest provides support for the head in order to achieve the best sitting position and to provide relief for the neck and spine even for users with poor body control. It can easily be adjusted to achieve the best setting for the individual user. Available in flat, curved or ErgoMedic Plus-versions.

COVER

The covers protect the upholstery from dirt and dust, as well as extending the upholstery's lifetime. Covers are available in different colours for a variety of combinations. Incontinency covers are a quick and easy solution to protect seats against moisture.

ARMREST

The Hemiplegi-armrest is suitable for partially paralysed, or users with restricted control. The armrest panel has been hollowed out, which makes it easier to keep the paralysed arm on the rest. The armrest panel also rotates, which allows for the best possible position. The mobile armrest panel is upholstered with extra foam for optimised comfort.

SIDE SUPPORT

The side supports help the user maintain stability and position. These can also be used as thigh supports, so that the users feet are better supported on the footrests or the floor, and prevents their legs from sliding apart. It can be adjusted for height and width, or turned backwards and forwards. Available in three sizes: S, M and L.

SLOW RECOVERY SEAT AND OTHERS

Slow Recovery-seats are manufactured with two materials in the cushioning, which provides optimum support and comfort to the user.

The upper layer comprises of a memory foam that moulds itself, and provides good pressure distribution and increased sitting comfort, while the lower layer raises the seat bone nodules from the wood plate. Even if the user does not sit in the chair for a sufficiently long period of time, the seat cushion adjusts itself so that a cavity is formed where the person sits. This material is available for all upholstered parts.

The wooden seat disc should be used when casting or retrofitting of its shell. The seat with anti-slip is recommended when using individually adjusted seats. Seat with hygiene fabric should be used by users with incontinence problems. This seat is to be completed with a cover in plush.



Trunk support, width x height

- 1 Trunk support cushion 15x13 cm
- 2 Trunk support curve- and adjustable

Article No.

- TS1046
- TS2038

Neckrest, width x height

- 3 Neckrest cushion Straight 29x16 cm NS1046
- 4 Neckrest cushion Curved 31x18 cm NS3046

Article No.

Armrest

- 6 Armrest ErgoMedic 25 cm
- 6 Armrest ErgoMedic 30 cm
- 6 Armrest ErgoMedic 35 cm
- 6 Armrest ErgoMedic 40 cm
- 7 Armrest Mobile 25 cm
- 7 Armrest Mobile 30 cm
- 7 Armrest Mobile 35 cm
- 7 Armrest Mobile 40 cm
- 8 Armrest Hemiplegic 45x12 cm

- AR101038
- AR102038
- AR103038
- AR104038
- AR301038
- AR302038
- AR303038
- AR304038
- AR406038

Article No. Article No. for angle

- 240387
- 240386
- 240385
- 240388
- 245387
- 245386
- 245385
- 245388
- 244387

- 9 Wooden seat disc

- ST10xx90

- 10 Wooden seat disc with anti-slip

- ST10xx61

Side support, width x height

- 11 Side support cushion XS, 15x8 cm
- 12 Side support cushion S, 28x8 cm
- 13 Side support cushion M, 24x14 cm
- 14 Side support cushion L, 30x16 cm

Article No.

- SS1046
- SS2046
- SS3046
- SS4046

Covers

- 5 Exist in plush, patterned fabric and incontinence material. Please see www.mercado-medic.co.uk or ontact Mercado for more information.

- 16 Seat ErgoMedic with hygiene fabric. To be completed with cover in plush.

Seat Slow Recovery Size in width x depth

- 15 33x35 cm
- 15 36x39 cm
- 15 36x43 cm
- 15 40x39 cm
- 15 40x43 cm
- 15 40x48 cm
- 15 44x43 cm
- 15 44x48 cm
- 15 48x48 cm

Slow Recovery ErgoMedic

- ST115046
- ST114546
- ST114046
- ST113546
- ST113046
- ST112546
- ST112046
- ST111546
- ST111046

Slow Recovery ErgoMedic Coxit

-
-
-
- ST143546
- ST143046
- ST142546
- ST142046
- ST141546
- ST141046

Slow Recovery ErgoMedic PLUS

- ST215046
- ST214546
- ST214046
- ST213546
- ST213046
- ST212546
- ST212046
- ST211546
- ST211046

Slow Recovery ErgoMedic PLUS Coxit

-
-
-
- ST243546
- ST243046
- ST242546
- ST242046
- ST241546
- ST241046



UPHOLSTERY

FOR REAL 2000, 9500/9600 EL, 9200 TWIN/EL

To rehabilitate the body after a serious accident is usually a long process. With proper rehabilitation, this process can be shortened. A prerequisite for short rehabilitating is the availability of good ergonomic aids. An ergonomically correct seating system helps reduce the patient's pain following, for example, whiplash accidents or to find relief when standing/sitting work. This seating system also works great when the chairs are used as a technical means (e.g. feeding situations).

SEAT SADDLE CLASSIC 36X36 AND 41X41

Plan saddle seat "all-rounder", fits most.

SEAT SADDLE MEDIC 40X36

Rounded saddle seat that offers good positioning.

SEAT SADDLE ERGOMEDIC 40X36

Partially buried in the back, thus some relief for the tailbone.

SEAT SADDLE ERGOMEDIC 40X36, LOWERED NOSE, LOWERED FOR TAILBONE

Provides relief of tailbone and spine at the appropriate use of chest support.

SEAT SADDLE ERGOMEDIC LOWERED NOSE, PART SAWN REAR

Allows for maximum relief of tailbone, vertebral column and the "seat bones" at the appropriate use of chest support.

ROUND, CONICAL SEAT

The round, conical shape makes it possible to vary its position on the placement of bone and degree of pelvic

tilt. The shape also means reduced pressure under the thighs at the appropriate use of chest support.

STOMACH SUPPORT WITH DOUBLE TIP

Stabilizes a larger area which is often requested by impairments neck and thoracic spine.

The slightly thicker padding enable for thin people to find a suitable position.

STOMACH SUPPORT MEDIC TIP UP

Stabilization of the thoracic or chest area/low back when only small chest support is required.

STOMACH SUPPORT MEDIC TIP DOWN

Allows for stabilization of the lumbar/pelvic and leaving great freedom of movement for the legs.

The straight edge at the top is comfortable to rest arms against.

REAL 9200 TWIN/EL – EXTRA PADDED SEATS

Being overweight is often problematic in several ways. Extra padded seats provide relief.

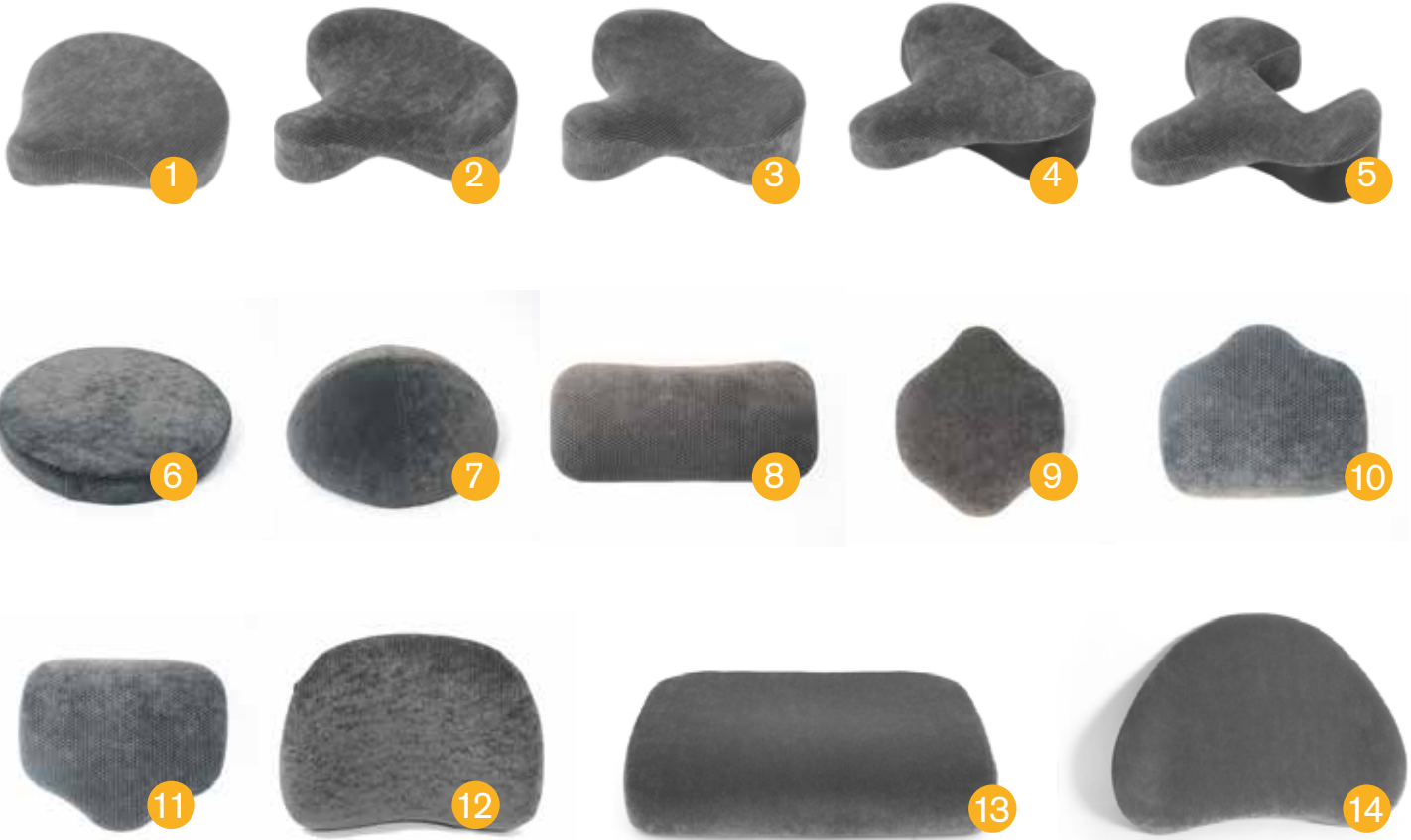

REAL 2000, 9500/9600 EL

Seat, width x depth

		Article no.
1	Seat Saddle Classic 36x36	ST324746
1	Seat Saddle Classic 41x41	ST322346
2	Seat Saddle Medic 40x36	ST333646
3	Seat Saddle ErgoMedic 40x36	ST343646
4	Seat Saddle Sawn f. Tailbone 40x36	ST363646
5	Seat Saddle part sawn Rear 40x36	ST373646
6	Seat Round Diameter 35	ST305146
6	Seat Round Diameter 40	ST303846
7	Seat Round Diameter Conical 35	ST315146

Backrest and Stomach support, width x height

8	Backrest Classic 33x16	BR109046
9	Stomach support double tip 27x27	BR416746
10	Stomach support Medic 27x23	BR406946
11	Stomach support Medic 27x23	BR406946
12	Backrest ErgoMedic 33x26	BR106046

REAL 9200 TWIN/EL

Seat, width x depth

		Article no.
13	Seat Twin 72x50	ST406046
13	Seat Twin 62x50	ST406346
13	Seat Twin 52x50	ST406646
13	Seat Twin 72x45	ST406146
13	Seat Twin 62x45	ST406446
13	Sits Twin 52x45	ST406746
13	Seat Twin 72x40	ST406246
13	Seat Twin 62x40	ST406546
13	Seat Twin 52x40	ST406846

Backrest, width x height

14	Backrest Twin 66x43	BR500646
14	Backrest Twin 65x42	BR500846
14	Backrest Twin 46x43	BR501046

FITTED ARTICLES

Mercado produces all upholstered furnishings inhouse. We can as well manufacture these in any special size, material, clothing, etc. (please see page 22).

MEASUREMENTS FOR BACKRESTS

ErgoMedic

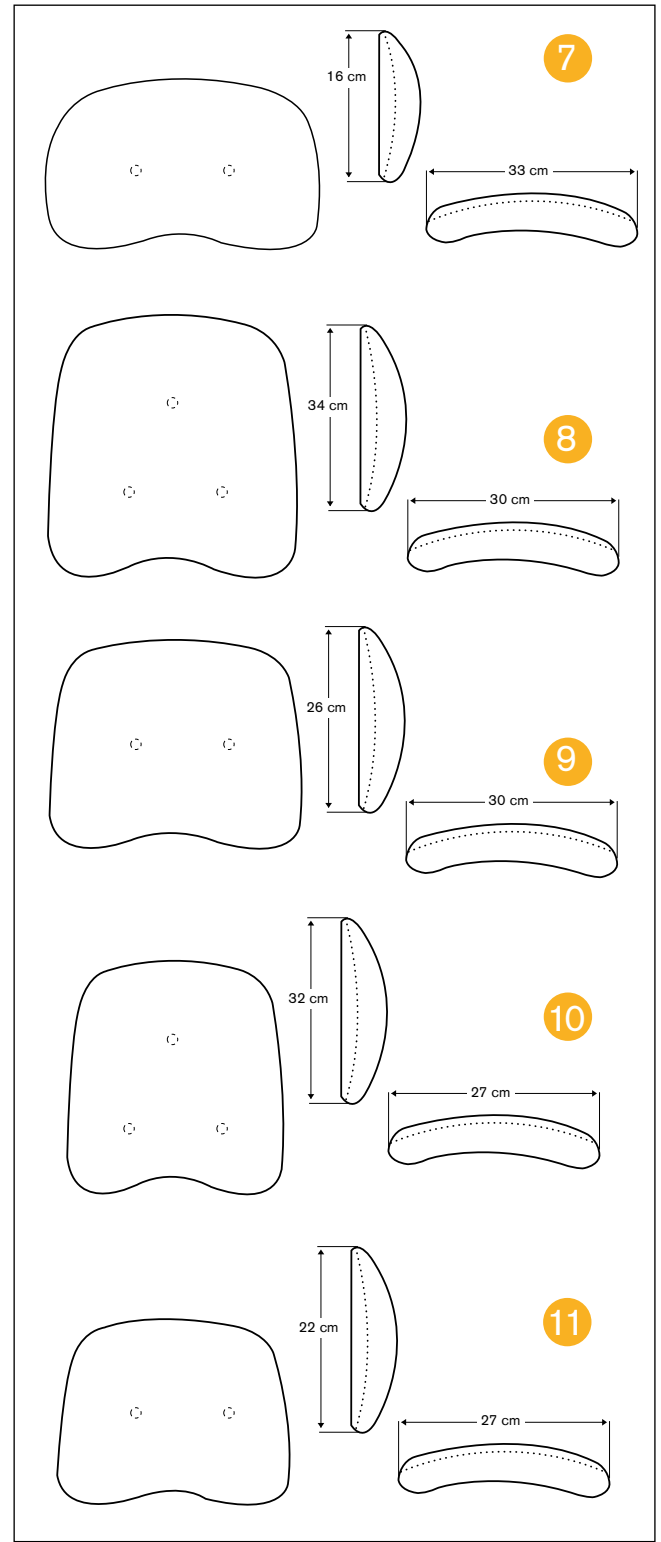
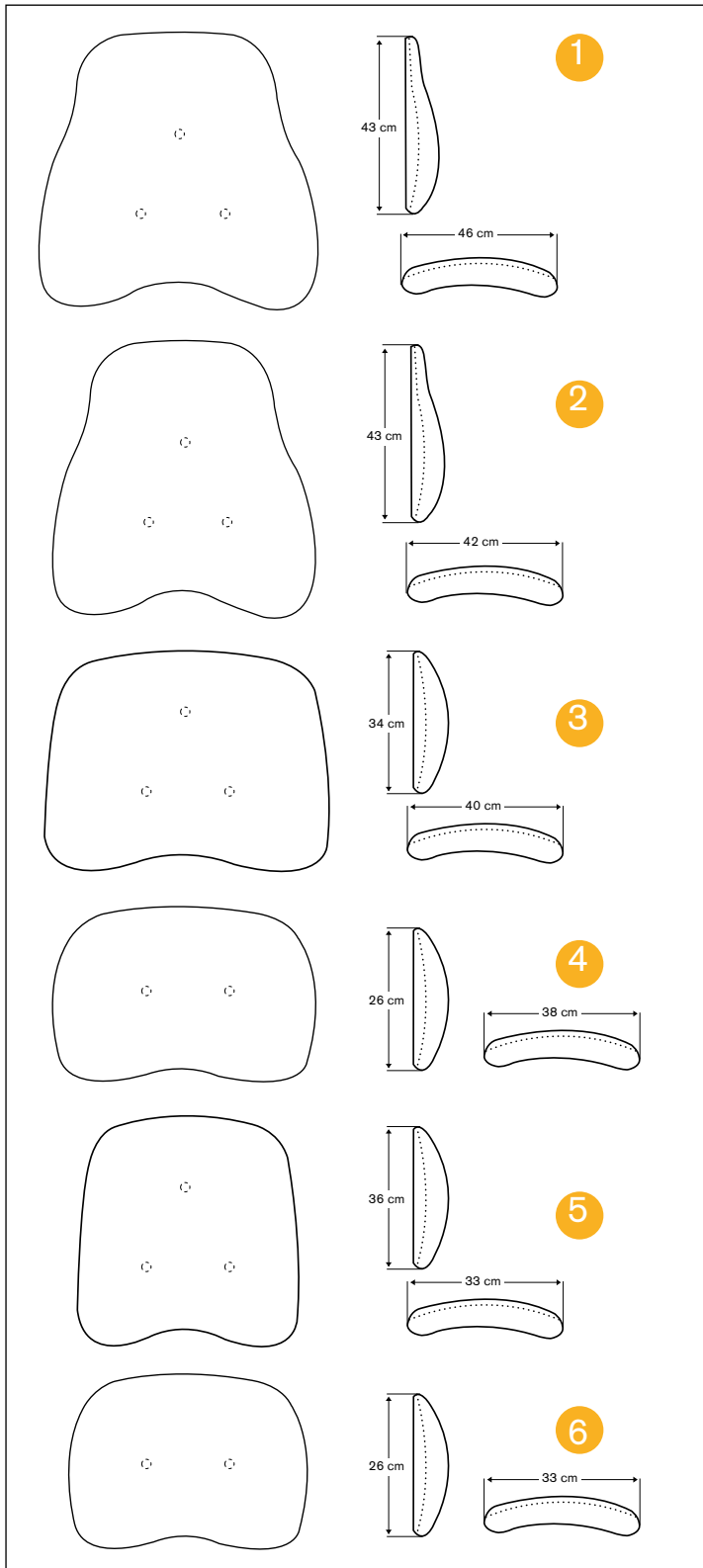

1	Size: 46x43 cm	Art.no: BR101046
2	Size: 42x43 cm	Art.no: BR101546
3	Size: 40x34 cm	Art.no: BR103046
4	Size: 38x26 cm	Art.no: BR105546
5	Size: 33x36 cm	Art.no: BR102546
6	Size: 33x26 cm	Art.no: BR106046

7	Size: 33x16 cm	Art.no: BR109046
8	Size: 30x34 cm	Art.no: BR103546
9	Size: 30x26 cm	Art.no: BR106546
10	Size: 27x32 cm	Art.no: BR104546
11	Size: 27x22 cm	Art.no: BR107046
12	Size: 23x27 cm	Art.no: BR105046
13	Size: 23x20 cm	Art.no: BR108546

ErgoMedic PLUS

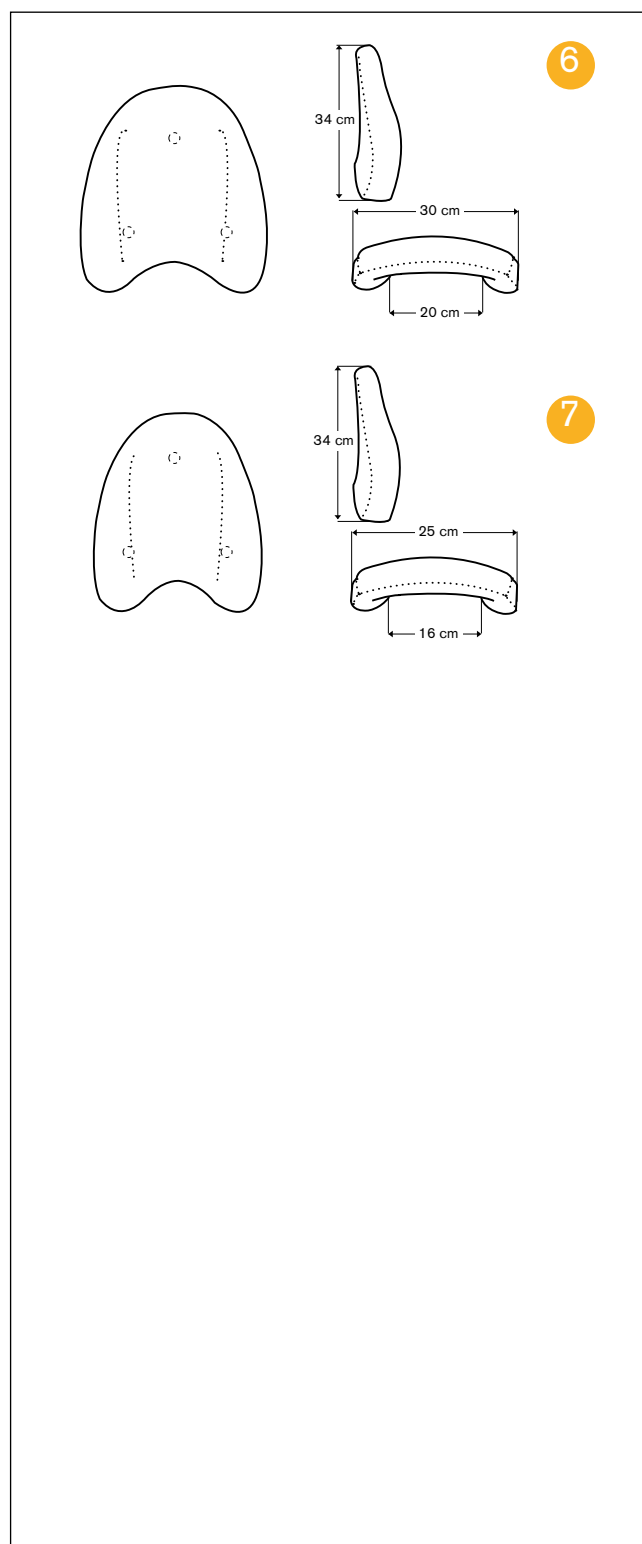
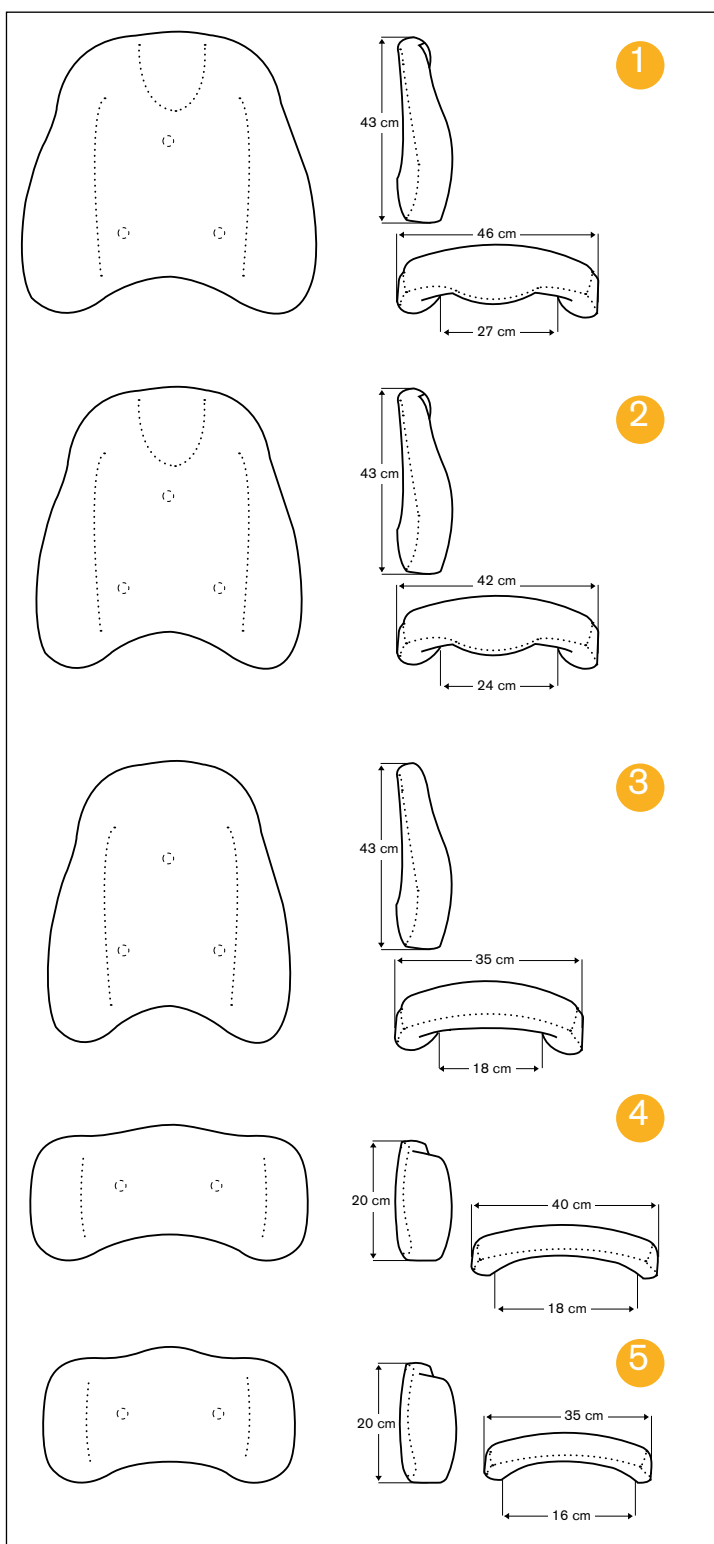

- | | | |
|---|-------------------|------------------|
| 1 | Size: 46x43 cm | Art.no: BR201046 |
| 2 | Size: 42x43 cm | Art.no: BR201546 |
| 3 | Storlek: 35x43 cm | Art.no: BR202046 |
| 4 | Size: 40x20 cm | Art.no: BR207546 |
| 5 | Size: 35x20 cm | Art.no: BR208046 |

- | | | |
|---|----------------|------------------|
| 6 | Size: 30x34 cm | Art.no: BR203546 |
| 7 | Size: 25x34 cm | Art.no: BR204046 |

ErgoMedic PLUS with wedge

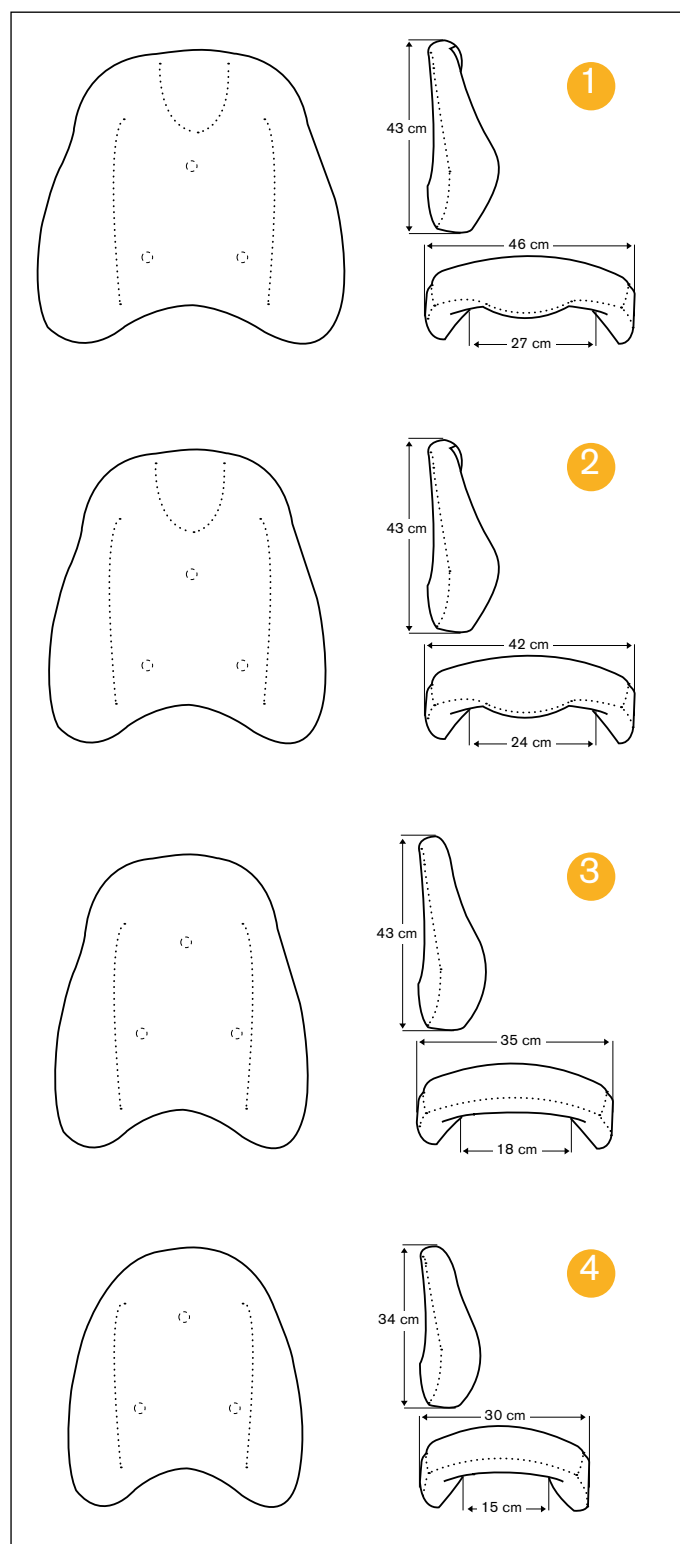

- | | | |
|---|----------------|------------------|
| 1 | Size: 46x43 cm | Art.no: BR251046 |
| 2 | Size: 42x43 cm | Art.no: BR251546 |
| 3 | Size: 35x43 cm | Art.no: BR252046 |
| 4 | Size: 30x34 cm | Art.no: BR253546 |

ErgoMedic PLUS with reinforced wedge

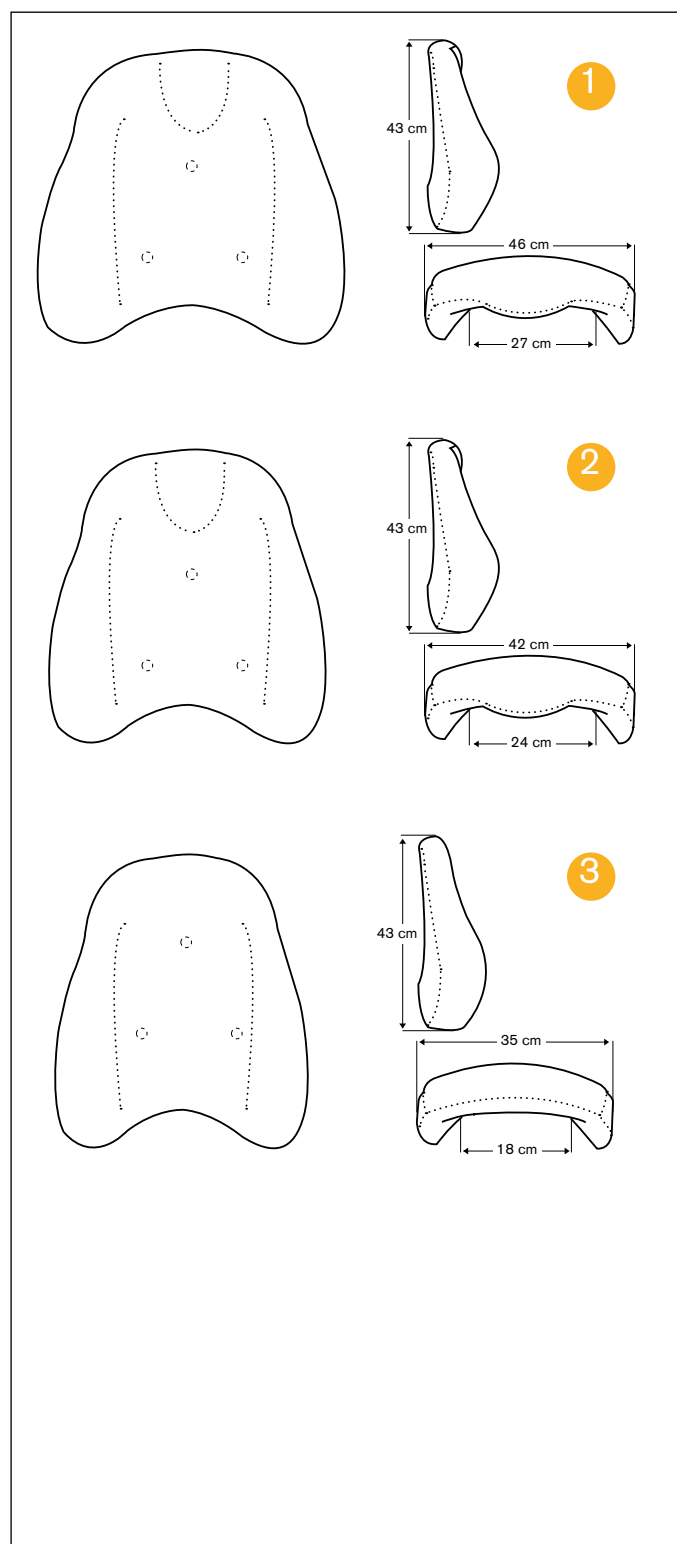

- | | | |
|---|----------------|------------------|
| 1 | Size: 46x43 cm | Art.no: BR351046 |
| 2 | Size: 42x43 cm | Art.no: BR351546 |
| 3 | Size: 35x43 cm | Art.no: BR352046 |

ErgoMedic PLUS Comfort



- 1 Size: 46x43 cm Art.no: BR211046
- 2 Size: 42x43 cm Art.no: BR211546
- 3 Size: 35x43 cm Art.no: BR212046

ErgoMedic PLUS Comfort with wedge

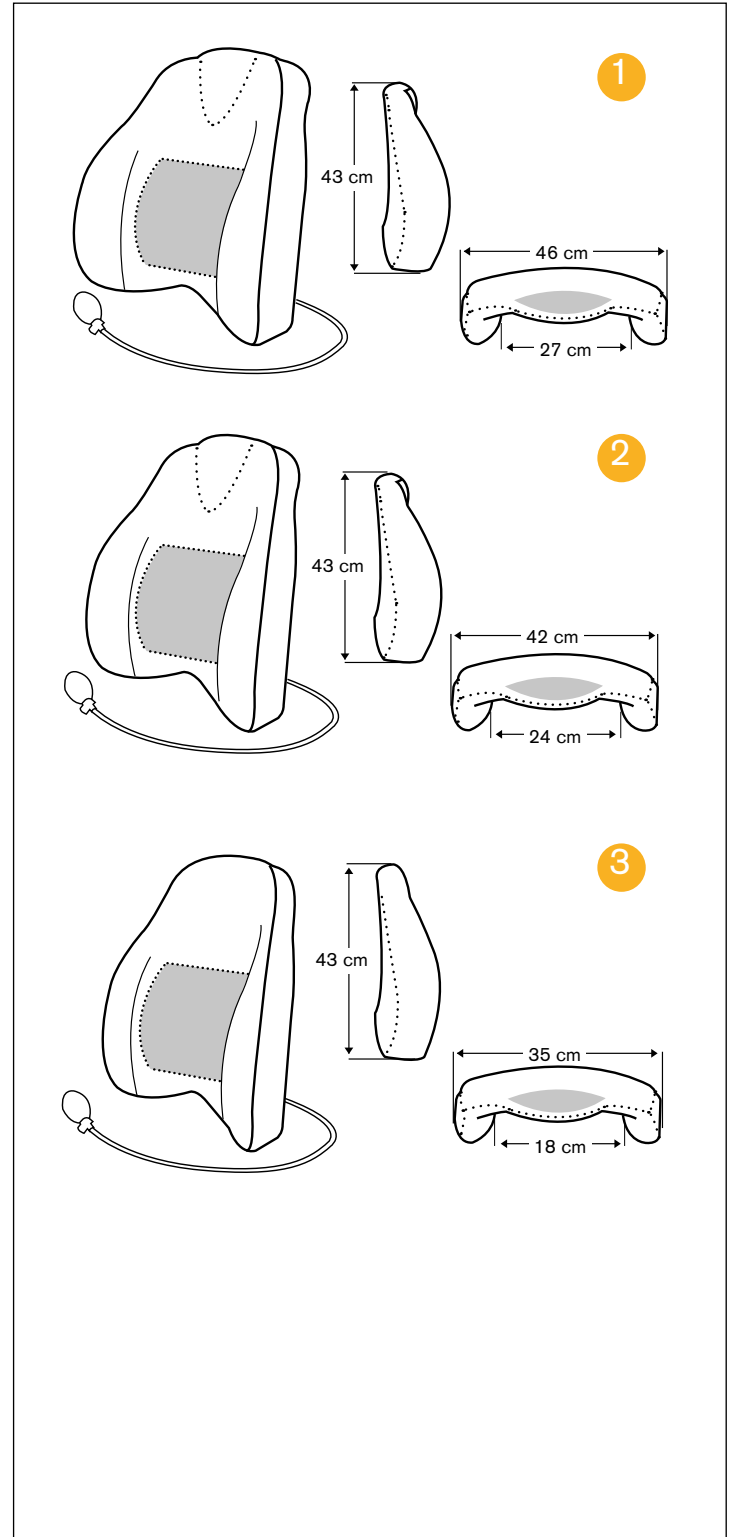

- 1 Size: 46x43 cm Art.no: BR261046
- 2 Size: 42x43 cm Art.no: BR261546
- 3 Size: 35x43 cm Art.no: BR262046

MEASUREMENTS FOR SEATS

ErgoMedic

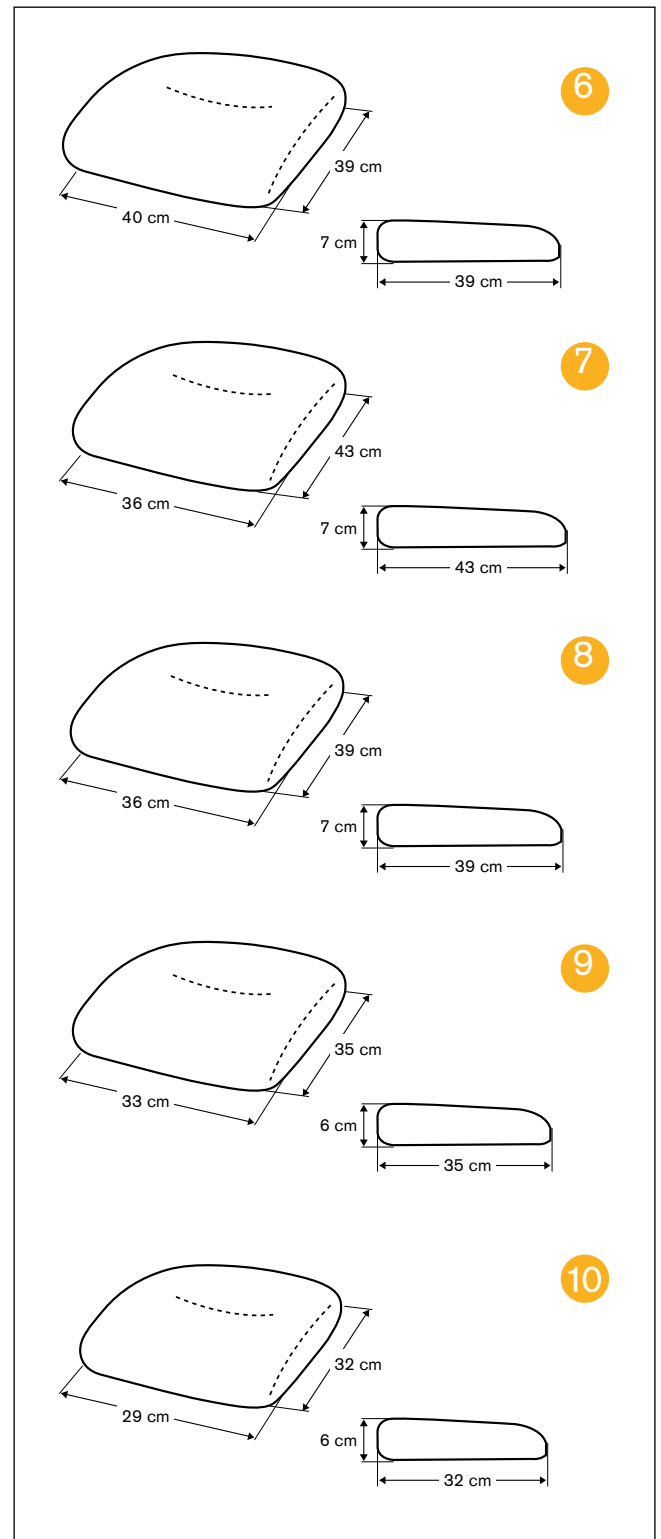
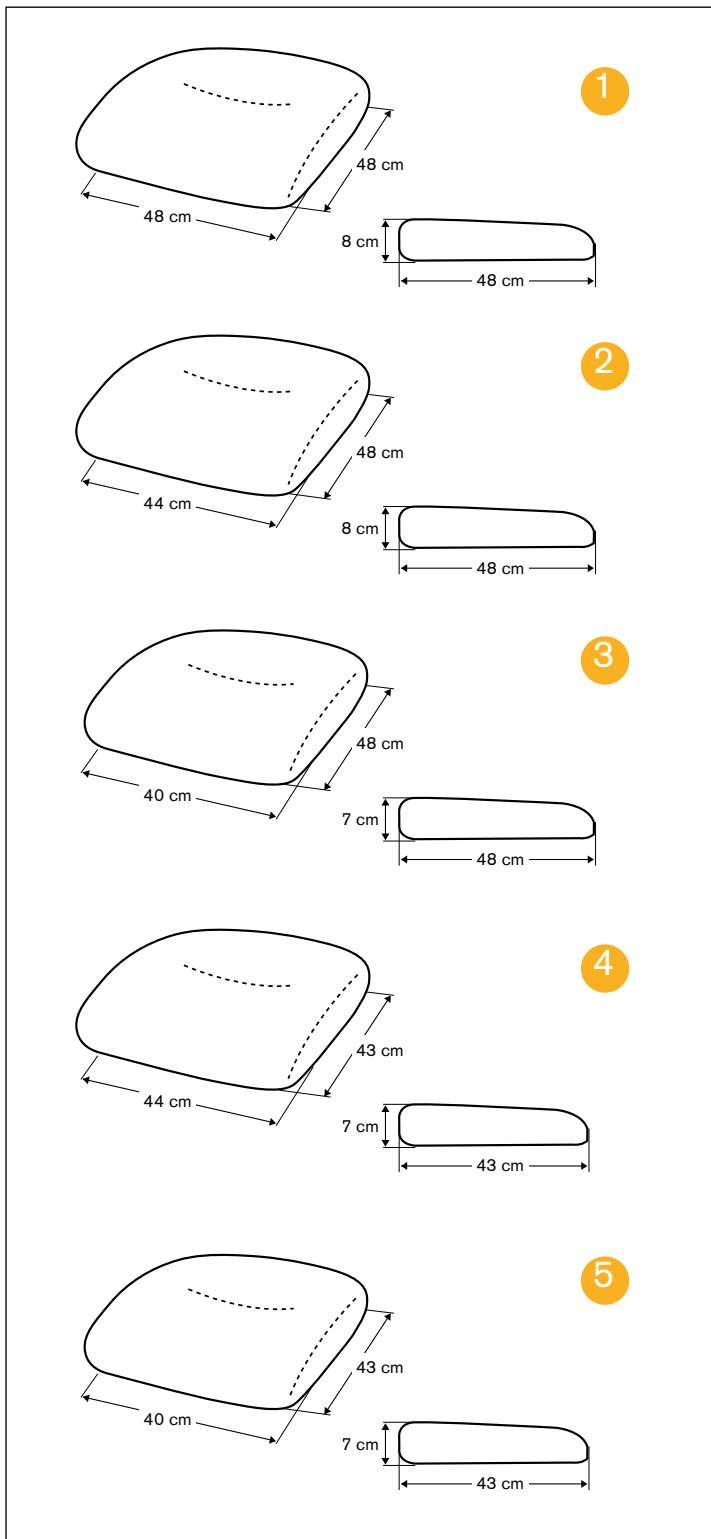

1	Size: 48x48 cm	Art.no: ST101046
2	Size: 44x48 cm	Art.no: ST101546
3	Size: 44x43 cm	Art.no: ST102046
4	Size: 40x48 cm	Art.no: ST102546
5	Size: 40x43 cm	Art.no: ST103046

6	Size: 40x39 cm	Art.no: ST103546
7	Size: 36x43 cm	Art.no: ST104046
8	Size: 36x39 cm	Art.no: ST104546
9	Size: 33x35 cm	Art.no: ST105046
10	Size: 29x32 cm	Art.no: ST105546

ErgoMedic Slow Recovery

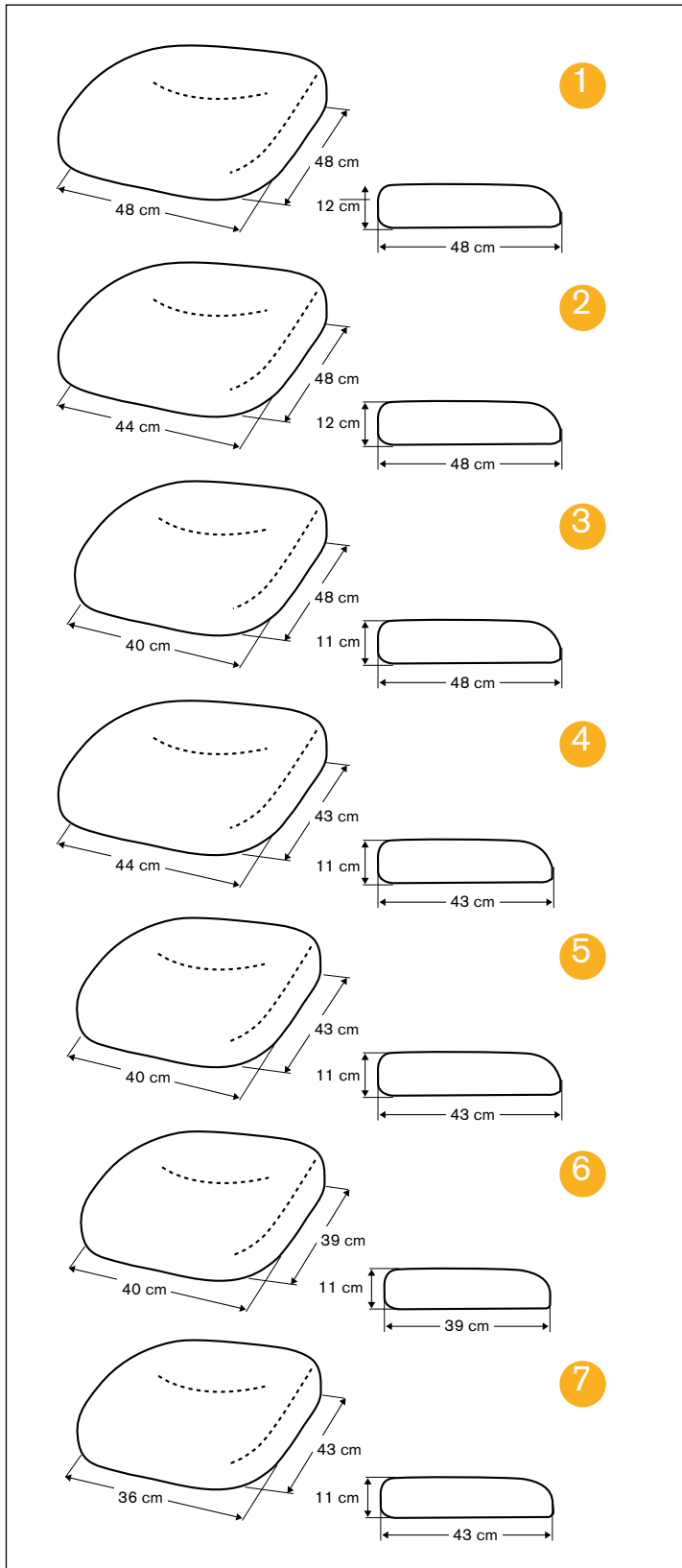

1	Size: 48x48 cm	Art.no: ST111046
2	Size: 44x48 cm	Art.no: ST111546
3	Size: 44x43 cm	Art.no: ST112046
4	Size: 40x48 cm	Art.no: ST112546
5	Size: 40x43 cm	Art.no: ST113046
6	Size: 40x39 cm	Art.no: ST113546
7	Size: 36x43 cm	Art.no: ST114046

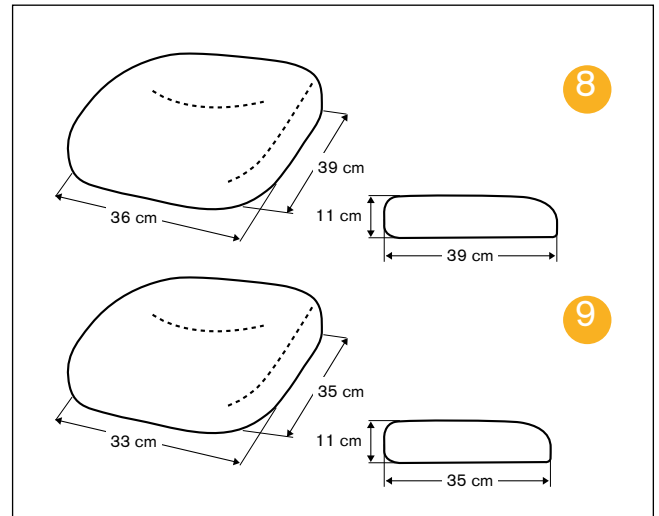

8	Size: 36x39 cm	Art.no: ST114546
9	Size: 33x35 cm	Art.no: ST115046

Wooden seat disc

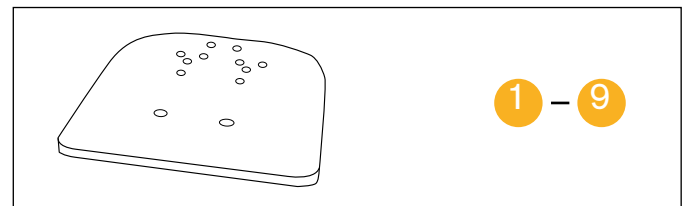

1	Size: 48x48 cm	Art.nr: ST101090
2	Size: 44x48 cm	Art.nr: ST101590
3	Size: 44x43 cm	Art.nr: ST102090
4	Size: 40x48 cm	Art.nr: ST102590
5	Size: 40x43 cm	Art.nr: ST103090
6	Size: 40x39 cm	Art.nr: ST103590
7	Size: 36x43 cm	Art.nr: ST104090
8	Size: 36x39 cm	Art.nr: ST104590
9	Size: 33x35 cm	Art.nr: ST105090

Wooden seat with Anti-slip

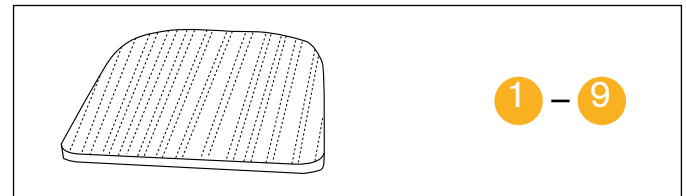

1	Size: 48x48 cm	Art.no: ST101061
2	Size: 44x48 cm	Art.no: ST101561
3	Size: 44x43 cm	Art.no: ST102061
4	Size: 40x48 cm	Art.no: ST102561
5	Size: 40x43 cm	Art.no: ST103061
6	Size: 40x39 cm	Art.no: ST103561
7	Size: 36x43 cm	Art.no: ST104061
8	Size: 36x39 cm	Art.no: ST104561
9	Size: 33x35 cm	Art.no: ST105061

ErgoMedic Coxit

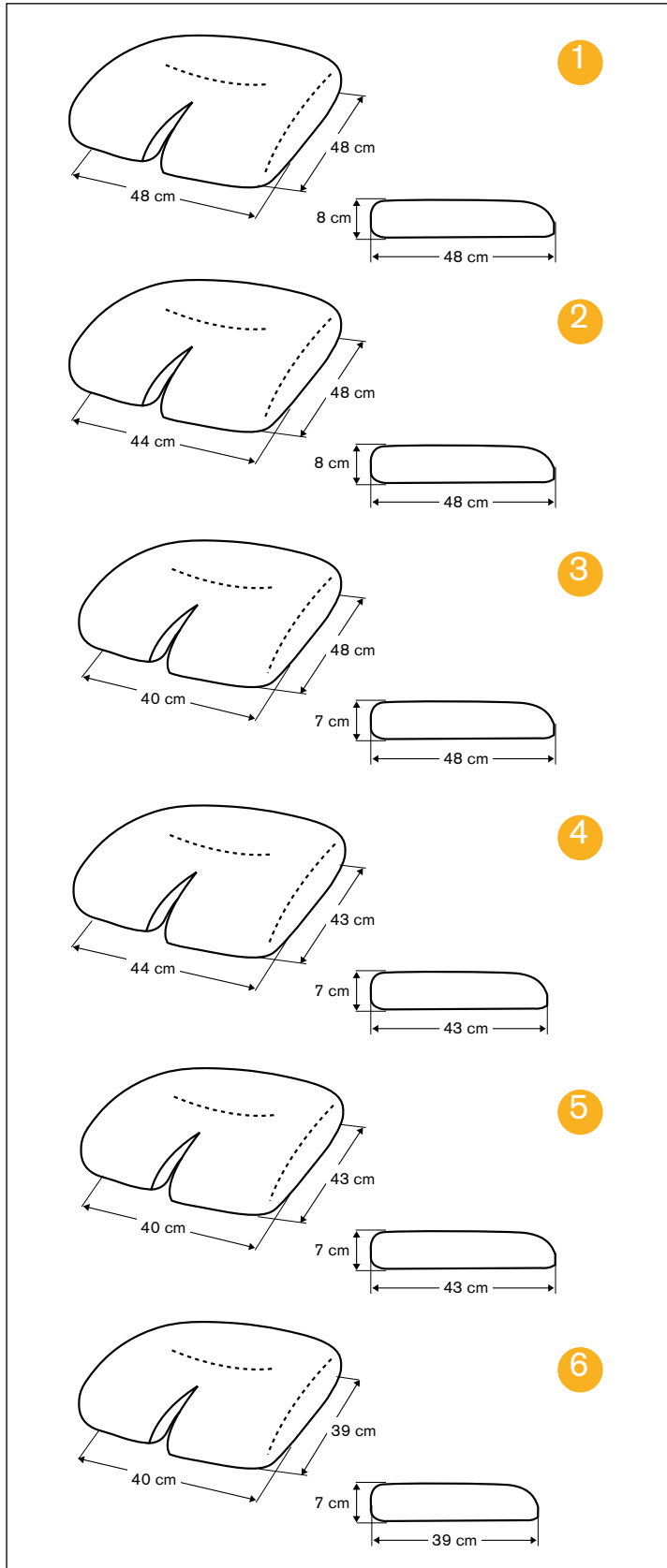

ErgoMedic Coxit Slow Recovery

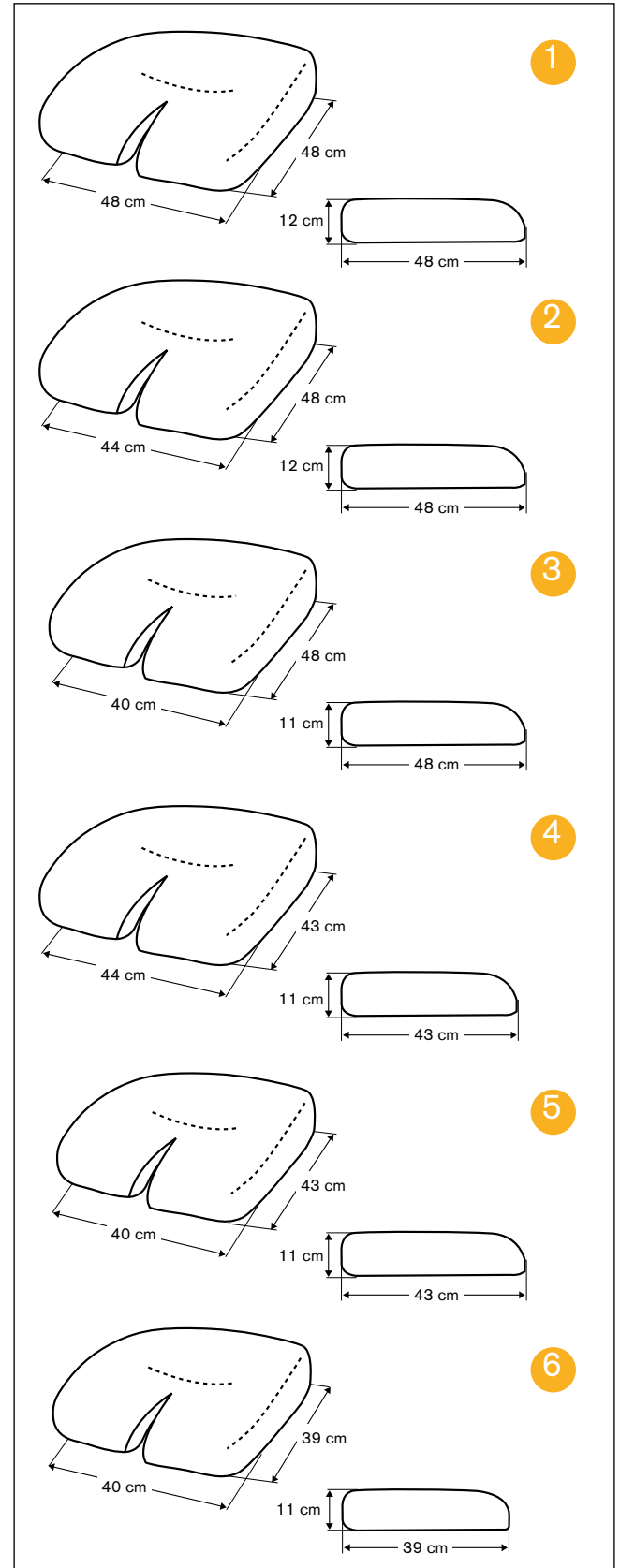

- | | | |
|---|----------------|------------------|
| 1 | Size: 48x48 cm | Art.no: ST131046 |
| 2 | Size: 44x48 cm | Art.no: ST131546 |
| 3 | Size: 44x43 cm | Art.no: ST132046 |
| 4 | Size: 40x48 cm | Art.no: ST132546 |
| 5 | Size: 40x43 cm | Art.no: ST133046 |
| 6 | Size: 40x39 cm | Art.no: ST133546 |

- | | | |
|---|----------------|------------------|
| 1 | Size: 48x48 cm | Art.no: ST141046 |
| 2 | Size: 44x48 cm | Art.no: ST141546 |
| 3 | Size: 44x43 cm | Art.no: ST142046 |
| 4 | Size: 40x48 cm | Art.no: ST142546 |
| 5 | Size: 40x43 cm | Art.no: ST143046 |
| 6 | Size: 40x39 cm | Art.no: ST143546 |

ErgoMedic PLUS

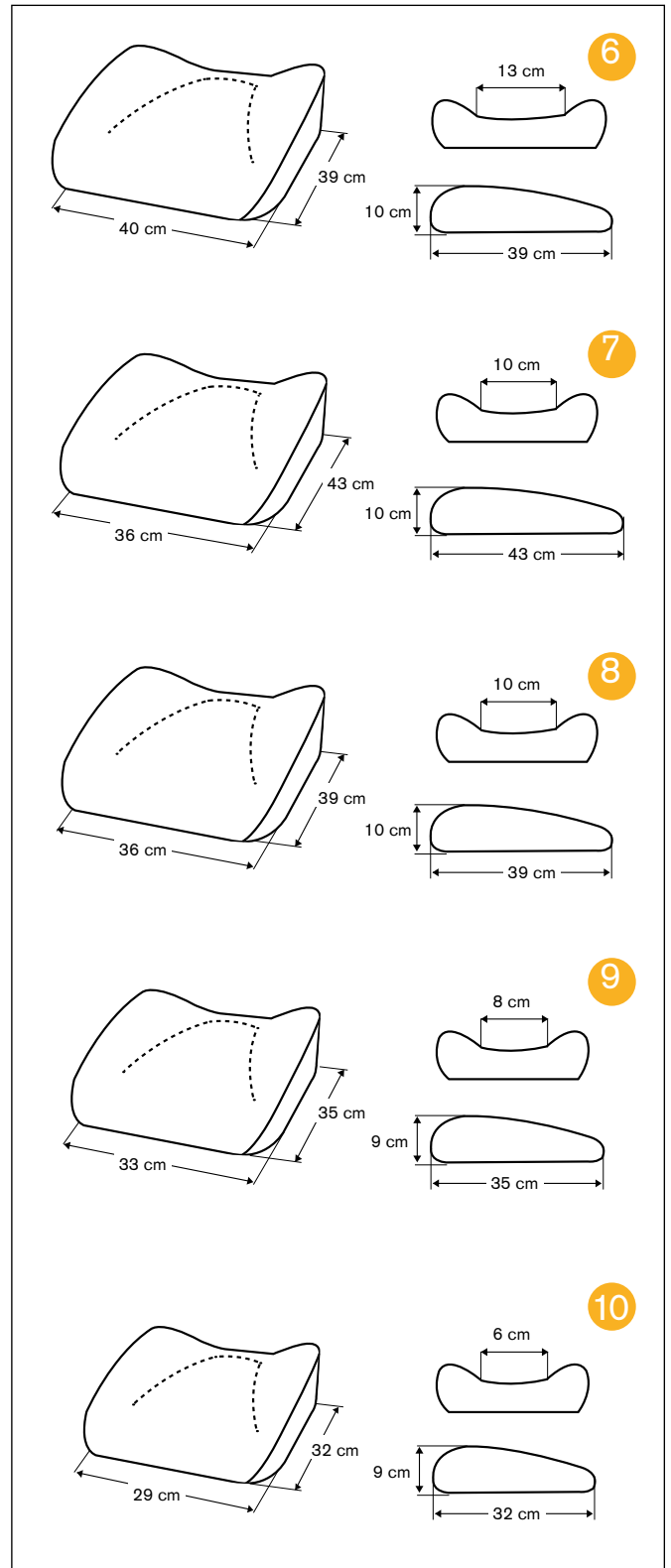
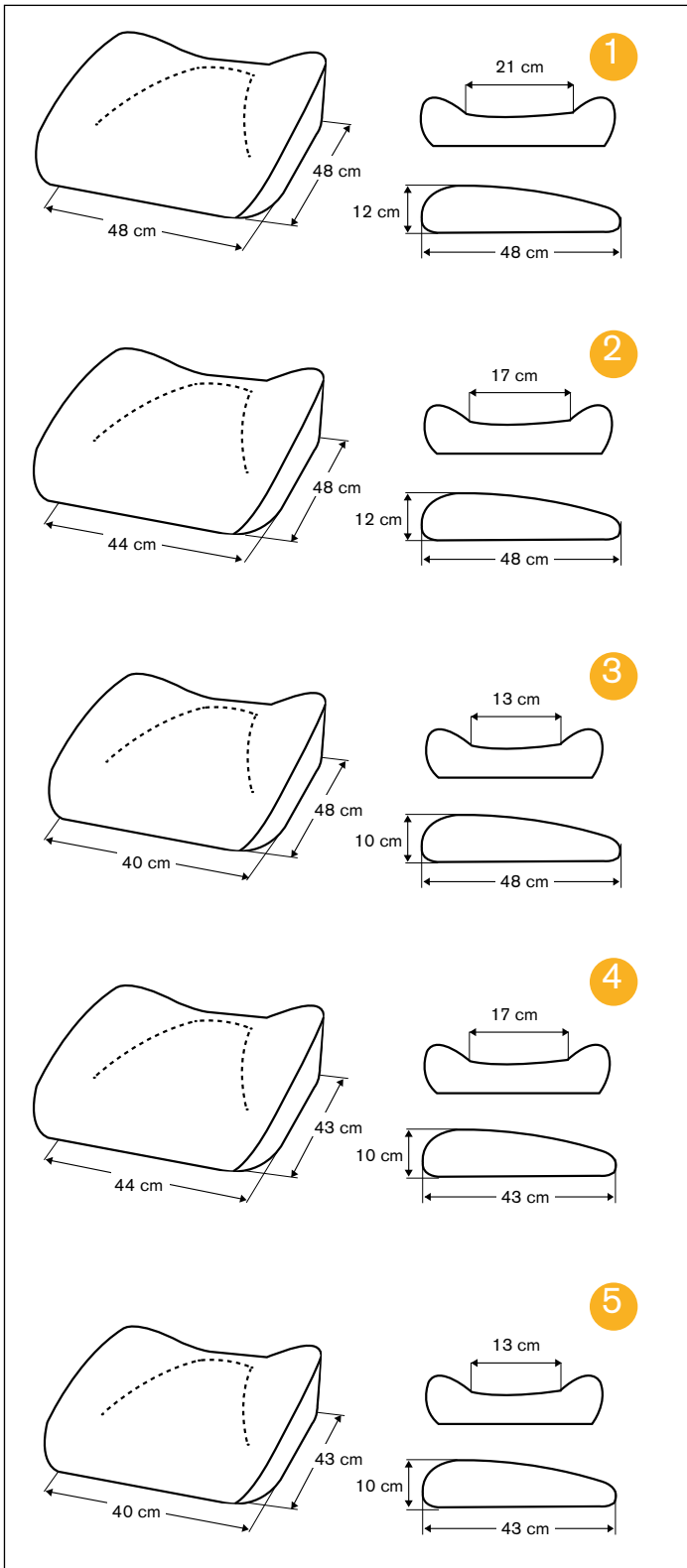

1	Size: 48x48 cm	Art.no: ST201046
2	Size: 44x48 cm	Art.no: ST201546
3	Size: 44x43 cm	Art.no: ST202046
4	Size: 40x48 cm	Art.no: ST202546
5	Size: 40x43 cm	Art.no: ST203046

6	Size: 40x39 cm	Art.no: ST203546
7	Size: 36x43 cm	Art.no: ST204046
8	Size: 36x39 cm	Art.no: ST204546
9	Size: 33x35 cm	Art.no: ST205046
10	Size: 29x32 cm	Art.no: ST205546

ErgoMedic PLUS Slow Recovery

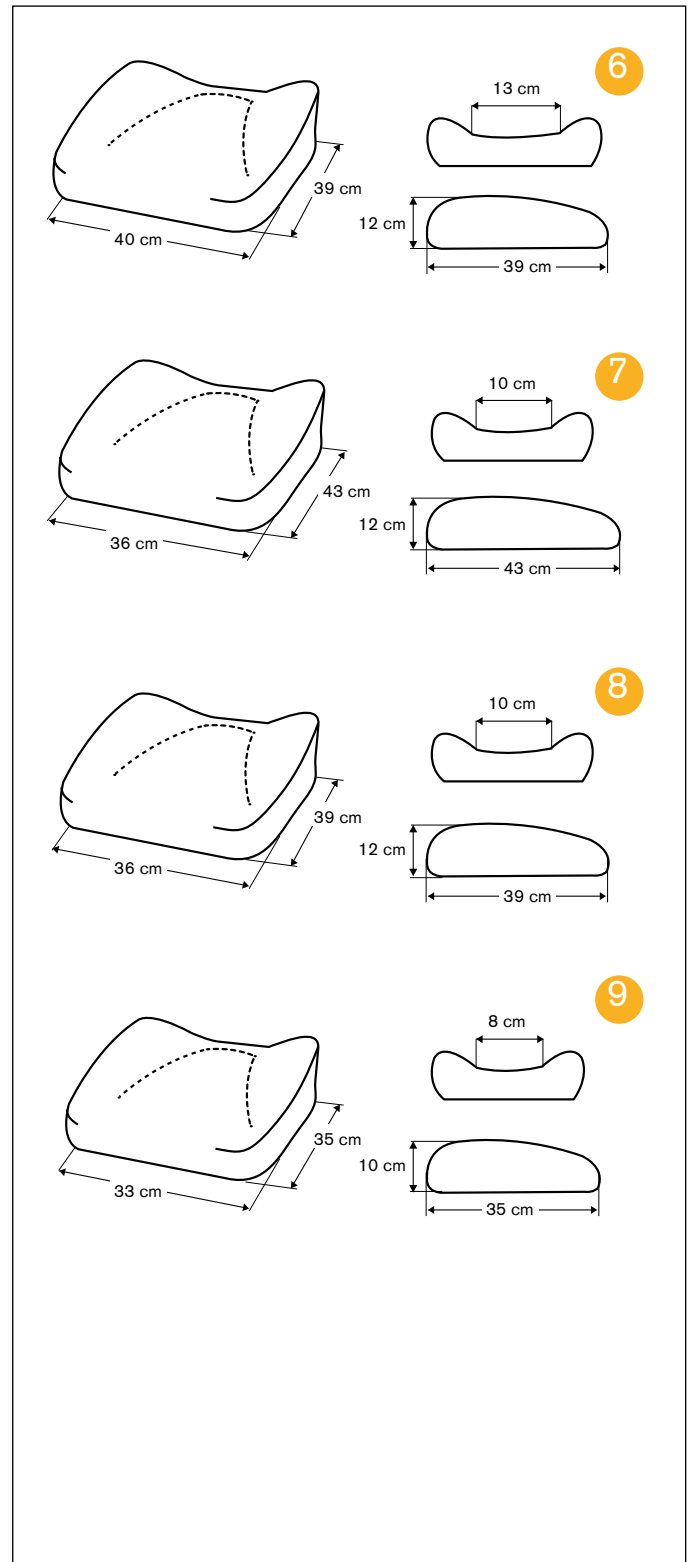
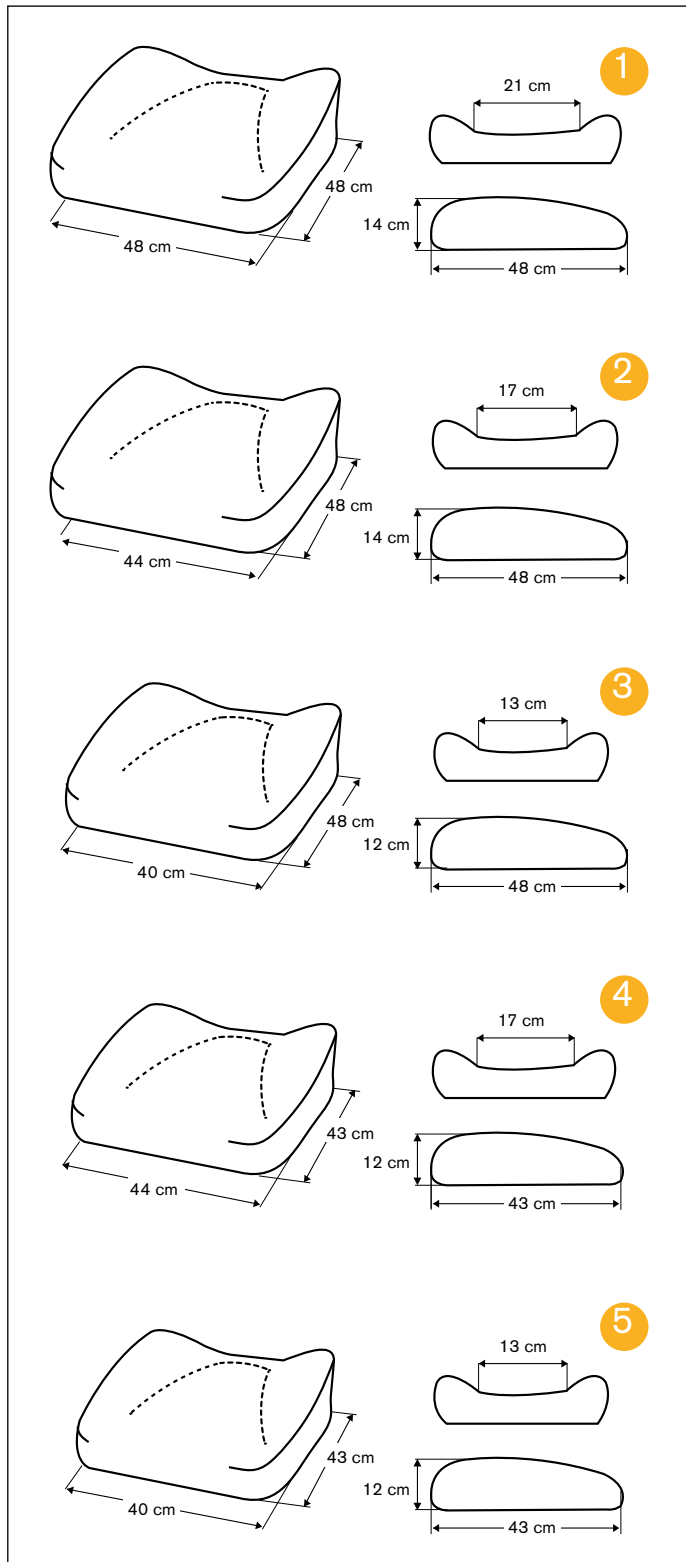

- 1 Size: 48x48 cm Art.no: ST211046
- 2 Size: 44x48 cm Art.no: ST211546
- 3 Size: 44x43 cm Art.no: ST212046
- 4 Size: 40x48 cm Art.no: ST212546
- 5 Size: 40x43 cm Art.no: ST213046

- 6 Size: 40x39 cm Art.no: ST213546
- 7 Size: 36x43 cm Art.no: ST214046
- 8 Size: 36x39 cm Art.no: ST214546
- 9 Size: 33x35 cm Art.no: ST215046

ErgoMedic PLUS Coxit

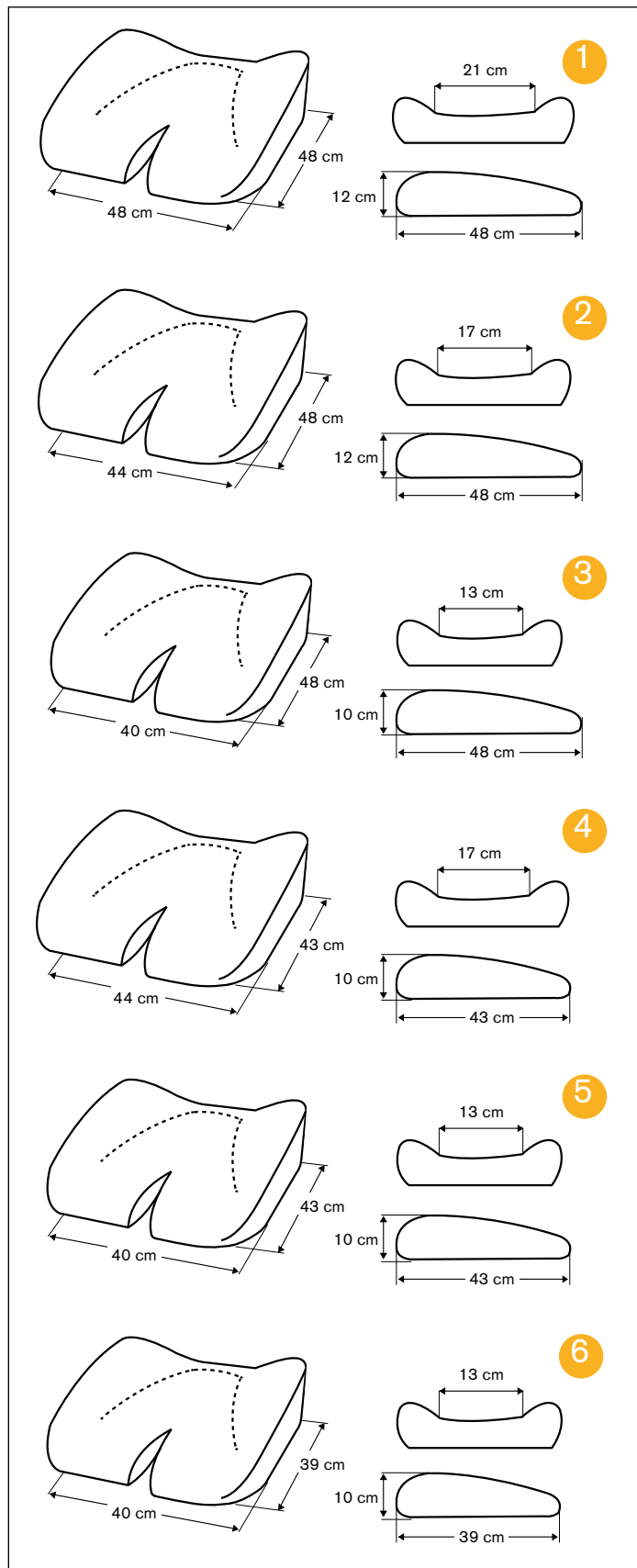

ErgoMedic PLUS Coxit Slow Recovery

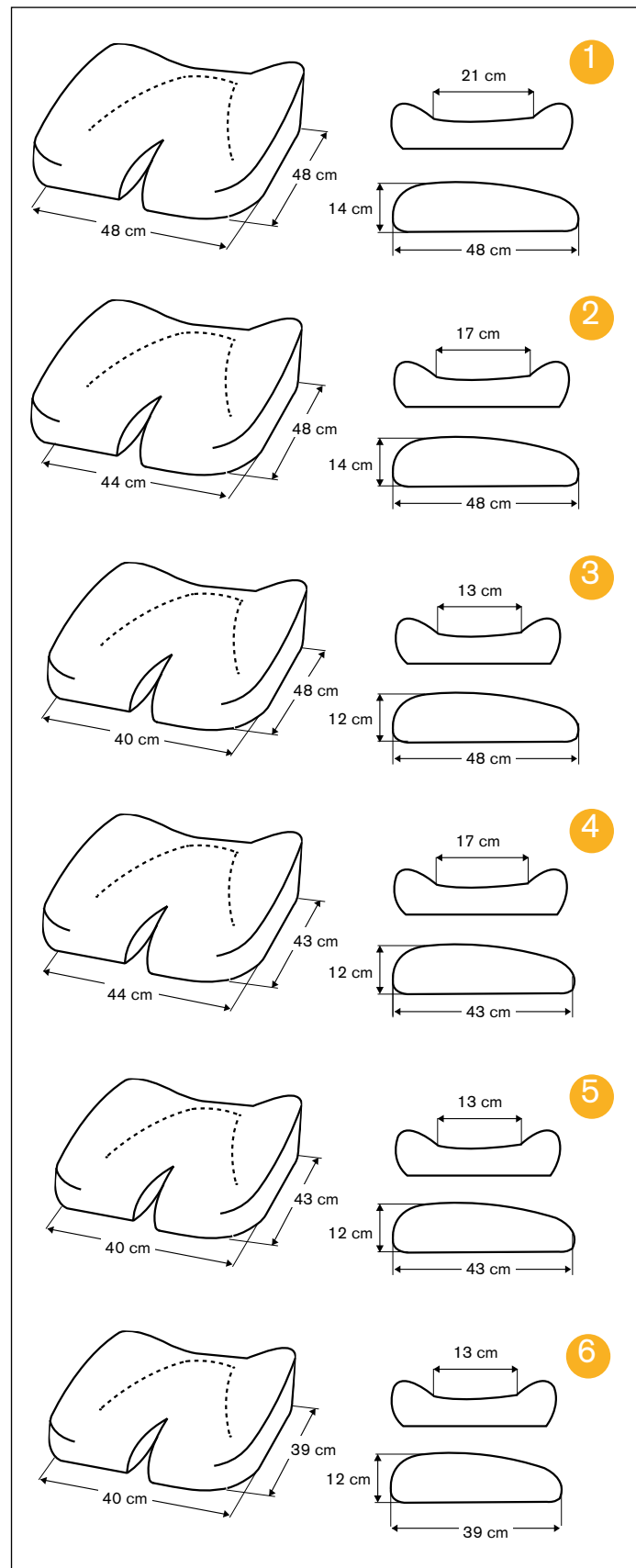

- | | | |
|---|----------------|------------------|
| 1 | Size: 48x48 cm | Art.no: ST231046 |
| 2 | Size: 44x48 cm | Art.no: ST231546 |
| 3 | Size: 44x43 cm | Art.no: ST232046 |
| 4 | Size: 40x48 cm | Art.no: ST232546 |
| 5 | Size: 40x43 cm | Art.no: ST233046 |
| 6 | Size: 40x39 cm | Art.no: ST233546 |

- | | | |
|---|----------------|------------------|
| 1 | Size: 48x48 cm | Art.no: ST241046 |
| 2 | Size: 44x48 cm | Art.no: ST241546 |
| 3 | Size: 44x43 cm | Art.no: ST242046 |
| 4 | Size: 40x48 cm | Art.no: ST242546 |
| 5 | Size: 40x43 cm | Art.no: ST243046 |
| 6 | Size: 40x39 cm | Art.no: ST243546 |

COVERING

PLUSH

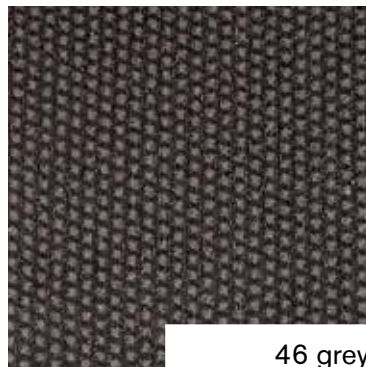
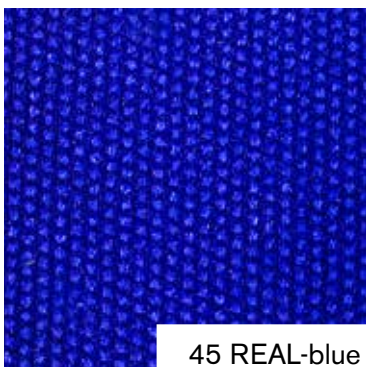
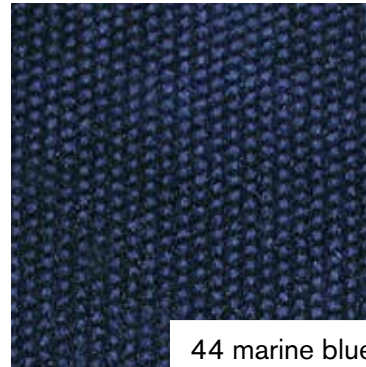
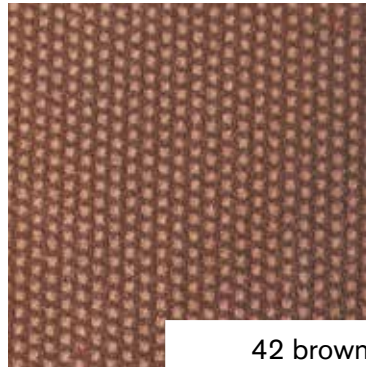
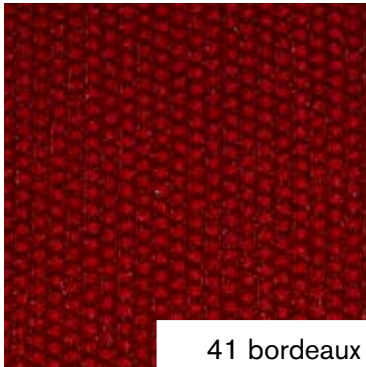

SKAI

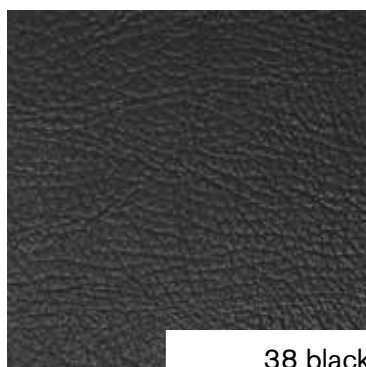
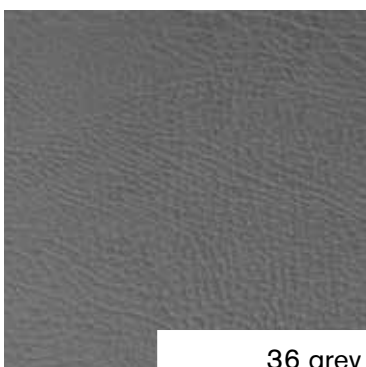
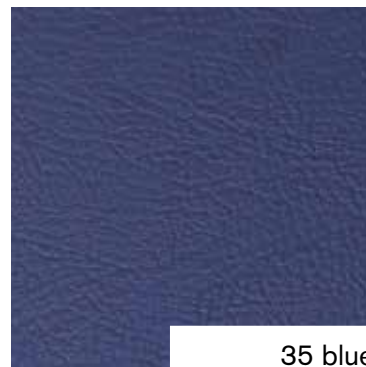

PATTERNED FABRIC ADULT

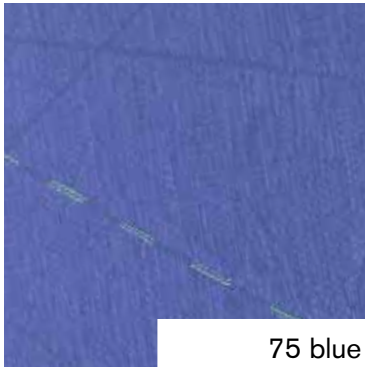

75 blue

EXPLANATION OF THE STRUCTURE OF THE ARTICLE NUMBER

Article No: **ST101546**
"ErgoMedic seat, plush grey 44x48 cm"

Digits 1-2 = Type of upholstered article
 Digits 3-4 = Seat system
 Digits 5-6 = Size
 Digit 7 = Material
 Digit 8 = Colour

PATTERNED FABRIC CHILD



81 red

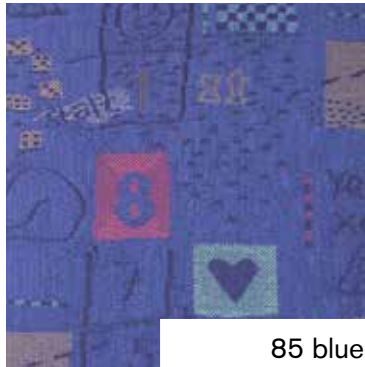

85 blue



89 yellow

ALTERNATIVE COVERING



60 hygiene fabric



95 without clothing

* Coverings are available in these colour codes; 41, 42, 44, 45, 46, 48, 75, 81, 85, 89, 66, 73, 74. Please go to www.mercado.se or contact us for more information.

COVERING*

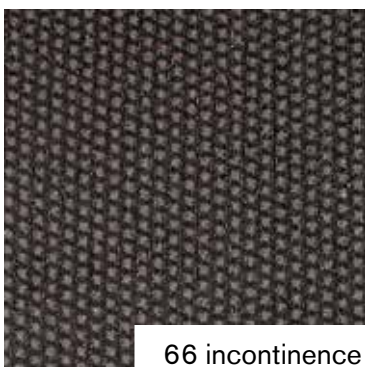

66 incontinence
(grey coated plush)



73 child/yellow
(cotton)



74 child/blue
(cotton)

FITTED ARTICLES

Mercado manufactures all upholstered furnishings inhouse. We can also manufacture these in any special size, material, clothing, and more. Download forms for adaptation from the website, www.mercado.se, under "Documents".

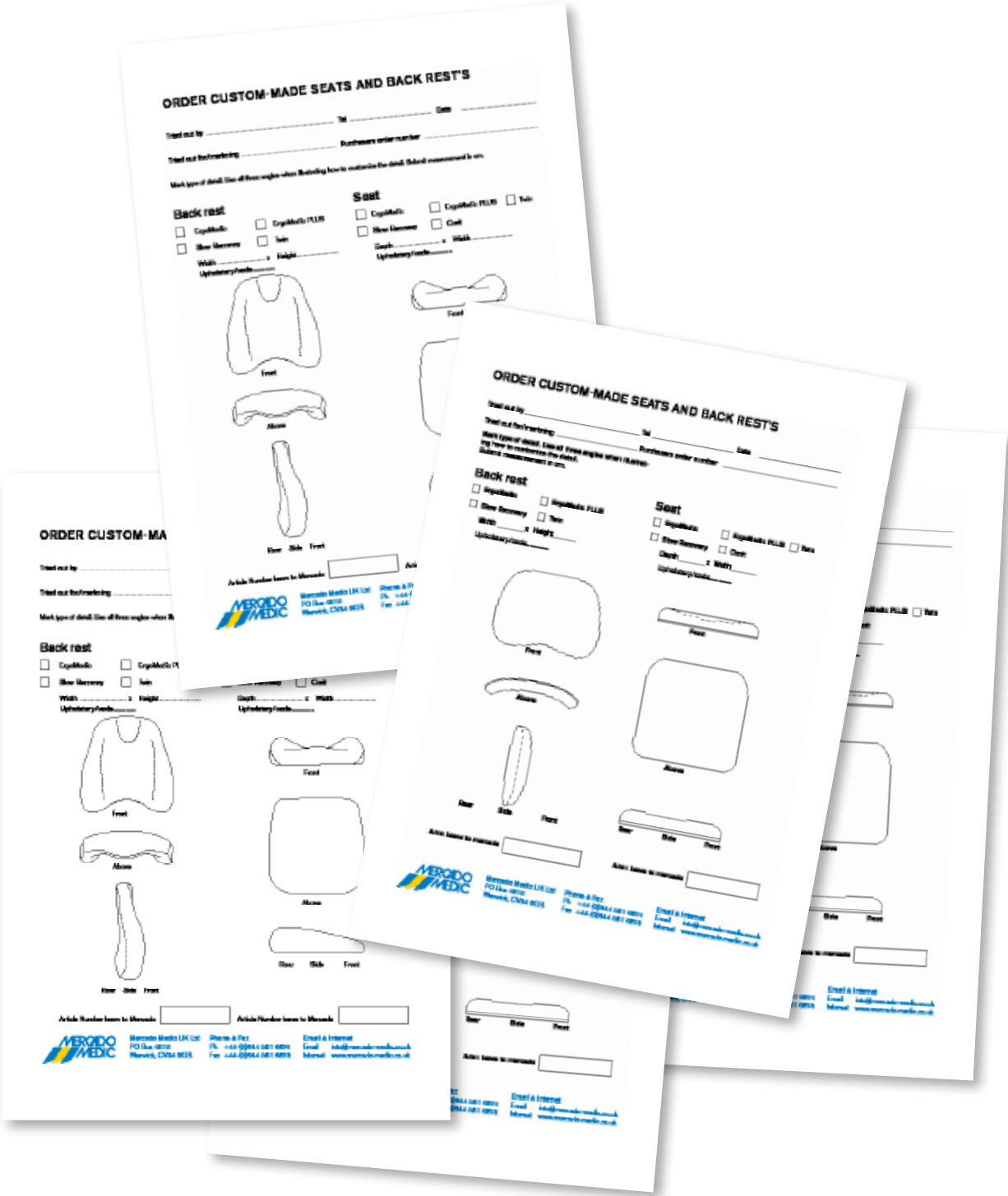





Mercado Medic AB
Tryffelslingan 14
181 57 Lidingö
Sweden

Phone & Fax
Ph + 46 8 555 143 00
Fax + 46 8 555 143 99

Email & Internet
Email info@mercado.se
Internet www.mercado.se